



ANNUAL REPORT 2016-17

DAYALBAGH EDUCATIONAL INSTITUTE
(DEEMED UNIVERSITY)
DAYALBAGH, AGRA

A NAAC ACCREDITED 'A' GRADE INSTITUTE
AN ISO 9001:2008 CERTIFIED INSTITUTE



Annual Report 2016-17

Content

Serial No.	Details	Page
1.	Director's Message	ii
2.	Executive Summary	iii
3.	Introduction	1
4.	Staff and Student Strength	11
5.	Programme of Study Offered	15
6.	Distance Education	23
7.	Institute Finance	29
8.	Central Facilities	33
9.	Infrastructure Development	37
10.	Distinguished Activities	43
11.	Awards and Recognition	55
12.	Seminar/Conferences/Workshops Organized in DEI	61
13.	New Initiatives	63
14.	Miscellaneous	67
	Annexure I	73
	Annexure II	89
	Annexure III	95
	Annexure IV	127

Director's Message

Since it was conferred by section 3 of the University Grants Commission Act 1956 the status of a deemed to be University in 1981, the DEI has grown as a flagship Institute of India, known and recognized for its innovative education policy, multidisciplinary & transdisciplinary teaching and research, known for the excellence in teaching, research, societal contribution to the local, national (rural, urban and tribal), and international communities.

The Dayalbagh Educational Institute is a unique institution with a vision and mission to achieve and sustain excellence in all fields such as academic, research, societal contribution, green environment, vocational and skill education, social service, women empowerment, inclusive growth and social justice.

It is following the path of truthfulness, equality, honesty, devotion, and dedication as the whole system of education is based on social values. The students are excelling like their teachers in all fields. Our staff and students strength has been growing year by year. During the period 2016-2017, we had -----undergraduate, -----post graduate, distance education, vocational education students.

We are pioneers in fields such as Solar Power, Vocational Education, Dairy Technology, Distance Education, and Consciousness studies and research.

Our vision is to cater to the educational need of the Least, Last, Lowest, and Lost individual of society. The Advisory Committee on Education (ACE), a Think Tank under the Chairmanship of Revered Prof. Prem Saran Satsangi Sahab, aims to generate innovative ideas for the uplift of the masses particularly the weaker sections. Our work – based training Courses educate and equip students to work in fields so that they are not only experts in their specialized area but can think creatively to solve the social problems and sustain their living.

For linking and widening the knowledge base of our students, and staff, and for the mutual benefits, we have build MOUs with academic, industrial, governmental, and non-governmental organizations. We are facilitators of the national interests and instrumental in promoting communal harmony.

We are meeting and excelling in the national standards. We continuously aspire to change the future by evolving an all rounded human race.

We welcome you to the Dayalbagh Educational Institute.

EXECUTIVE SUMMARY

ANNUAL REPORT: 2016-17

Dayalbagh Educational Institute (Deemed University) Dayalbagh, Agra

The Dayalbagh Educational Institute was granted the status of Deemed University under Section 3 of the UGC Act 1956 on the basis of its unique system of innovative, value-based quality education. It has great impact on the society and is instrumental in spreading peace and harmony in society which is validated by the print media “Dayalbagh Mein Kabhi Curfew Nahi Lagta” (Hindustan, Hindi Daily, 5.4.18). The mission of the Institute is to provide holistic education, so that students evolve into well-rounded individuals who can successfully face any challenge, social or professional, in today’s global world and can contribute to society in a constructive manner.

The DEI enunciated its Vision 1981-2031 with clear objectives, focusing on excellence in teaching and research. In its untiring pursuit of quality education, DEI has instituted an Internal Quality Assurance Cell (IQAC) based on NAAC’s specific guidelines. The drive for quality is augmented by two additional bodies - the ACE (Academic Committee on Education in Dayalbagh institutions), which is a ‘Think Tank’ of educationists from across the country; and AAA (Academic and Administrative Audit Committee).

To ensure a sustainable model of societal development, the DEI follows ‘Six Sigma Approach’ which has been framed by the most Revered Prof. P. S. Satsangi Sahab, Chairman, Advisory Committee on Education, DEI. It aims at achieving excellence in teaching and research through “Quality”, “Value”, “Innovation” and “Creativity”, in the following areas: Innovation in Education policy, Air Quality Monitoring, Water Quality Monitoring, Agriculture and Dairying, Value Education and Women Empowerment.

The DEI caters to educational (both formal and spiritual) needs of society from pre-school level i.e. three months to doctoral and post-doctoral levels. The Institute has faculty members as well as non-teaching staff members who are dedicated and diligent in their work. The strength of the students during 2016-17 was 5976 in the campus, 2961 in Distance Education. Besides having six faculties viz. Arts, Commerce, Education, Engineering, Science and Social Sciences, DEI also runs two Technical Colleges - one for girls and one for boys, four Intermediate Colleges and one High School.

Students are provided the opportunity for multiple entries and exits, as well as vertical and horizontal progression among Conventional, Professional, Technical and, Vocational Education. Integrated programmes of study such as Integrated BBM (Hons) with MBA, M.Phil. and Ph. D., Integrated B.Sc with M.Sc, M.Tech in Computer Science, and Integrated PGDBE-M.A. (Applied Economics)-M.Phil. & Ph.D. (Economics) are also offered. New programmes offered include B. Architecture, PGD in Human Rights and Social Work, and PGD in Urban Planning. The Institute has adopted a Continuous Evaluation and Grading System with an eleven-point grading system for academic assessment of students. To ensure

transparency in the system, all the course in-charges are required to upload marks of all the components of their course within the stipulated time on the Institute's website.

In the 34th convocation 2792 students were awarded degrees, 505 students received diplomas and 439 students were given certificates. The result of various examinations remained 96% to 100%. The President's Medal was awarded to Ms. Vedika Saxena for securing highest marks in all Undergraduate classes whereas Ms. Roma Pathak received it for securing highest marks at Post Graduate level. A total of 86 students were awarded Director's Medal for securing highest marks at various Under Graduate and Post Graduate levels. 35 students were awarded the degree of Doctor of Philosophy in this Convocation.

Students' placement has been improving. They are placed in industries, including MNCs (such as Crompton Greaves, Timex, Maruti Suzuki, Lava International, Fiat India, HCL, Sports Flash, TVS Motors, Honda Cars, Torrent Power Agra, SRF Ltd, TCS, Ernst & Young and AC Neilson).

During the session 2016-17, fellowships were disbursed to 168 research scholars, amounting to Rs.742.54446 lakh under various schemes such as NET Junior Research Fellowship, Rajiv Gandhi National Fellowship for OBCs, Maulana Azad Fellowship, ICSSR Doctoral Fellowship, UGC Research Fellowship and Kothari Post Doctoral Research Fellowship. There were 19 ongoing research projects sanctioned by various agencies (DST, MHRD, ICSSR, UGC, AICTE and BRNS) totalling 497.16428 lakhs.

During the financial year 2016-17, the UGC sanctioned Rs 2942.80 lakh as Maintenance Grant and Rs. 440.26 lakh as Plan Grant. The UP Government sanctioned a grant of Rs 1734.86 lakh as regular salary grant and Rs. 10.15 lakh for the National Service Scheme. The income from the investment from non-government sources amounted to Rs 654.71Lakh. The unit cost per student, works out to Rs. 12703/- (without Salary).

With the rise in student strength, the Institute has expanded its infrastructure in terms of construction of new buildings, development of ICT, purchase of computers, printers, furniture and other fixed assets.

New initiatives taken during 2016-17 include MoUs signed by the DEI with the following Universities/Institutes/Companies: Kiel University (CAU) Kiel, Germany; Indian Institute of Technology, New Delhi; Dr Y. S. Parmar University of Horticulture & Forestry, Nauni, Solan; Jain Irrigation Systems Limited, Jalgaon, Maharashtra; Ministry of Textiles, GoI, New Delhi; India Yamaha Pvt. Limited. Another significant initiative of the DEI is EVIC (Entrepreneurship Virtual Incubation), which adopts an inter-disciplinary systemic approach to promote creative thinking and an entrepreneurial mindset among students to help convert socially relevant innovative ideas into market acceptable products. The objective of EVIC is to nurture social entrepreneurs who will focus on providing low cost solutions in the domains of Education, Energy, Health, Water and Waste Management.

Chapter: 01

INTRODUCTION

Dayalbagh Educational Institute is an institute *sui generis* that symbolizes excellence. The uniqueness of this Institute lies in the fact that it instills in its members the qualities of hard work, perseverance, dedication and commitment towards progress. DEI aspires to have a value based educational policy. One of the aims of education here has been to impart quality education at low cost, and to produce students who are inspired to serve humanity through body, mind and ultimately spirit. Physical development of the body through sports and games, cognitive development of the mind through an inter-disciplinary academic programme, and a values-based, quality education that nurtures the spirit, all add up to raise the level of consciousness of DEI's students creating a breed of superwomen and supermen. Freedom of thought governs the academic environment here. Along with it, a critical culture is allowed to prosper. The habit of blind acceptance is not conducive to growth. DEI understands this and hence the questioning spirit finds space to grow. DEI's values-based approach is unique, and is operationalized through core courses, community service, agricultural activity, social service, rural development etc. Unlike other Institutes, these are not merely outreach activities that are peripheral to the mainstream. Instead, at DEI, they *are* mainstream, deeply woven into our education, as much a part of the academic programme as any traditional subject. The Core Courses are leveraged by us to make societal contributions, concern for the underprivileged being paramount. A '*jugaad*' approach to innovation teaches our students to develop products that are nature-friendly and affordable by all and reinforces the importance of reaching out to the last, the least and the lowest. By working selflessly to help the villagers, our students imbibe good values and ethics, altering their mindsets and destinies along with the destinies of others. Toiling for one's own bread runs in the veins. We must all have some practical knowledge of the art of growing our own crops. Only then can we appreciate the worth of farmers.

The strength of DEI is its students and faculty. Both follow the path of friendly coexistence. Students are taught the values of respect, which has to be earned. DEI strives for a healthy mind in a healthy body; hence NSS camps are organized each year. The Institution has adopted seven villages. The responsibility of cleanliness, propagation of literacy and the need to follow a hygienic regime amongst the villagers binds students and keeps them devoted to their duty. There is a sincere attempt to build up values, and implement value based educational policy. Values should be expressed through actions. The policies of DEI are such that these values get the right mode of expression.

“It is not a big university or big building or larger number of teachers or larger number of Departments which raises the status of a University. it is the quality of the work that makes a university great.”

Revered Prof. M. B. Lal Sahab
Founder Director, Dayalbagh Educational Institute

Dayalbagh Educational Institute



Philosophy and Milestone

While education builds one's physical and mental capacities, a value based education system lends a purpose to one's life. Therefore, it is of paramount importance to enrich the education system with values which give life a direction. This helps us to realize our worth and utilize our energies in the right direction to maximize the positive output.

Dayalbagh Educational Institute has realized the need of this century and therefore we believe in creating individuals who are holistic and humanistic instead of individuals who are driven by sheer avarice. DEI aims at producing individuals who earn their degrees with dignity and behave like truly educated persons. These individuals will act as agents of change who shall make this world a better place to live in. The frugal, '*jugaad*' approach to entrepreneurship at DEI instils in the students a frugal approach to life in general, minimizing one's own needs, and promoting sustainability by reducing one's footprint on the planet. Selfless service, exposure to those worse off than themselves and empathy with their problems translate into a desire to help others, moderation in habits, rejection of crass materialism and the blind pursuit of wealth. As key players for a cause greater than themselves, our students become aware that they hold the power to change society, to make a difference.

Since its inception, DEI has witnessed multi-dimensional growth. The DEI education policy lays emphasis on co-operative entrepreneurial education with multiple linkages, ranging from

household to international industry sector, through SEZ-NDBS, Satellite Big Villages (B), Satellite Medium Villages (M), Satellite Small Villages (S) framework for development of MSMEs in the country. The founder of Dayalbagh, His Holiness Sahabji Maharaj said, “Education, more education and education made perfect, is the only panacea for all our country’s ills and evils.”

Undoubtedly the elixir of perfect education can transform the human beings by taking them closer to the inner self and opening the inner eye. Dayalbagh Educational Institute endeavours to metamorphose ‘man’ into a ‘human being’, capable of a higher form of life, rich in intellectual, technological, moral, artistic and spiritual values.

There are three levels in Dayalbagh educational pattern with Primary, Secondary and Higher Education forming a hierarchy under the umbrella of DEI. This hierarchy is necessary from the beginning itself because quality higher education cannot be provided until the middle level is good enough to enter higher education. Similarly, the primary level should also meet expectations. These interlinkages and dependencies allow the whole education system to be complete and integrated. Hierarchical structure allows flow to be maintained by creating a gradient, ensuring that we remain kinetic and in constant ‘refresher’ mode naturally. At the third stage of the hierarchy is the highest level of spiritual education which takes the education beyond the gross physical, material plane, thus envisioning transcendence from Aparavidya to Paravidya.

The Institute has been marching gloriously to a steady beat, with the firm conviction that “Work is Worship”. Just to mention some milestones – in 2004 it established Women’s Polytechnic and the same year commenced the Distance Education Programmes. The landmark year 2008 witnessed the establishment of DEI-ICT Distance Education centre at MTV Puram, Tamilnadu and Soami Nagar, New Delhi. In 2009 DEI ICT Distance Education centers at Rajaborari-Timarni, District Harda, MP were established. In 2010 the Quantum-Nano systems centre: Research and Technology Park was established. Our “Skilling to Entrepreneurship” approach is self-sustaining and ensures that no one is denied an opportunity for personal growth and development, benefitting society at large. The entrepreneurship model that has emerged allows students to self-support their education, making them job creators rather than job seekers.

The glorious journey guided by the indefatigable spirit of “Why not?” continued with the establishment of DEI ICT Distance Education Centre at Bangalore and the Centre for Consciousness Studies at DEI in 2011. More recently in 2014, DEI –ICT Distance Education Centre has been established at Murar (Bihar). A glance at the past and its uninterrupted continuity culminating in the present makes us rapturous as now the programmes are offered in 87 Study Centres in India and 7 abroad. The Institute has also evolved a unique concept of e-DEI–de to offer fully-online delivery of Certificate courses, Diplomas and Degree Programmes through e-DEI – Distance education.

The Institute strives to impart innovative and comprehensive education which aims at excellence along with relevance. The mission objective of DEI is the development of “complete man” or “complete human being”. Its comprehensive, integrated and inter-disciplinary education aims to provide students not only a first-rate broad based academic education, but also to learn some craft or industrial technique, till and toil with their hands, imbibe basic human values, spirit of tolerance and respect for other religions and to get prepared for the service of humankind. The ideal of ‘Fatherhood of God and Brotherhood of Man’ is one of DEI’s foundational teachings, and reflects how deeply we have internalized reaching out to those on the lowest rung of society’s ladder.

Dayalbagh Educational Institute: A Distinguished Center of Learning

On 16th May, 1981 Dayalbagh Educational Institute (DEI), Dayalbagh, Agra, received the honour of the status of a ‘Deemed University’ by the Government of India under Section 3 of the University Grants Commission Act 1956.

Location:

Dayalbagh Educational Institute is located at Dayalbagh in Agra, Uttar Pradesh, India. Its geographical coordinates are 27 degree 13’0” North, 78 degree 1’0” East. Dayalbagh is a self-contained colony renowned for its serene environment, pollution free, and secular establishments, in which its inhabitants lead an active, disciplined, and cooperative community life, conforming to the high spiritual ideals of their faith.

Area: 17.8 Hectares

Covered Area: 57101.5 Square Meters

Working Days in the Institute: For Instruction - 248, For Research 288

Mission:

Since its inception in 1981, the Institute has successfully implemented an innovative, comprehensive and value based education system with the mission objective to evolve a complete person through physical, intellectual, emotional and ethical integration. This complete person will be imbued with moral and spiritual values (e.g. simple living, selfless service, dignity of labour), and possess social sensibilities (e.g. tolerance for diversity, understanding of rural life and social forces and needs). In pursuance of its mission objective the DEI’s innovative curriculum includes core courses that are run across the Institute at all levels as part of the curriculum and form a crucial component of its value-based education. They include Comparative Study of Religion, Agricultural Operations, rural development, Environmental Studies, General Knowledge and Current Affairs, and Social Service. It is evident that the very nature of these Core Courses exposes students to the problems of the lowest and the poorest, forges connections with rural residents, and encourages community service, especially through agricultural activities such as sowing and harvesting of crops etc. They also instil in our students dignity of labour and respect for those who ‘till, toil and soil’ their hands. It also includes work based training programmes that take the form of practical training in areas related to the major subjects. The distinguishing feature of DEI’s education policy is its emphasis on combining excellence with relevance to contemporary needs.

To ensure continuous monitoring and enhancement of quality coupled with innovation and relevance to current social & educational needs, the DEI has constituted a “Think Tank” (ACE) of reputed faculty drawn from within and outside the Institute. The Committee meets regularly every two months to review progress and consider proposals for future action. It is chaired by the most Revered Prof. P.S Satsangi Sahab, former Director (1993-2002) of the Institute and former Professor & Dean, Students Affairs at IIT, New Delhi. Internal Quality Monitoring through a systematic feedback mechanism is being undertaken by AAA.

Vision 2031

The Dayalbagh Educational Institute has embarked upon a bold initiative, VISION 2031 and formulated a comprehensive and progressive Strategic Plan for 2012-2031, with the goal to become a top teaching-cum-research Institute through an exemplary system of education. To establish Total Quality Management across all activities of the Institute, the plan encompasses undergraduate and postgraduate education, research, infrastructure, information and communication technology and campus development.

Keeping in line with the Institute's unique scheme of innovative, comprehensive, interdisciplinary and value-based education that fosters academic excellence with holistic development, the Strategic Plan is a road map for providing an environment to produce well-rounded students who are ready to take on challenges and be leaders with a fine blend of top quality academics, work-experience and a strong value system.

The Strategic Plan is action-oriented and embodies the spirit of "Why Not?" It will be implemented in four phases, each of five years, with clear targets set for each phase.

The Institute has accepted this challenge and is confident of achieving success with the cooperation of faculty, staff, students, alumni and all other well-wishers.

The DEI Education Policy

The Dayalbagh Educational Institute, a registered body, charted out a comprehensive educational policy in 1975 which foreshadowed many provisions incorporated not only in the National Education Policy of 1986, but also those being currently launched by the Government of India at present, for instance in its Skill India Mission.

In the words of Revered Prof. P. S. Satsangi Sahab, Chairman Advisory Committee on Education: *"The DEI Education Policy is an innovative, comprehensive and flexible higher and technical education policy with the mission objective of evolving a "complete man" (total quality person), which conforms to the concept of total quality management and is geared for transformation of India to a knowledge society."*

NAAC ACCREDITATION & MHRD RANKING:

The DEI was awarded "A" Grade by the NAAC, UGC. DEI was ranked eighth among 126 Deemed Universities/Institutions of Higher Learning in India by a high-powered committee set up by the Ministry of Human Resource Development.

Focus on Quality Based Education

Using the medium of an innovative, comprehensive and flexible education policy, DEI attempts to chisel out a total quality person through persistent focus on imparting quality education. In its pursuit of quality education, DEI has instituted an Internal Quality Assurance Cell (IQAC)

based on the specific guidelines of the National Assessment and Accreditation Council, an autonomous body set up by the UGC.

The activities of the IQAC envelop the Institute central administrative structure, Institute departments and every component of the Institute system.

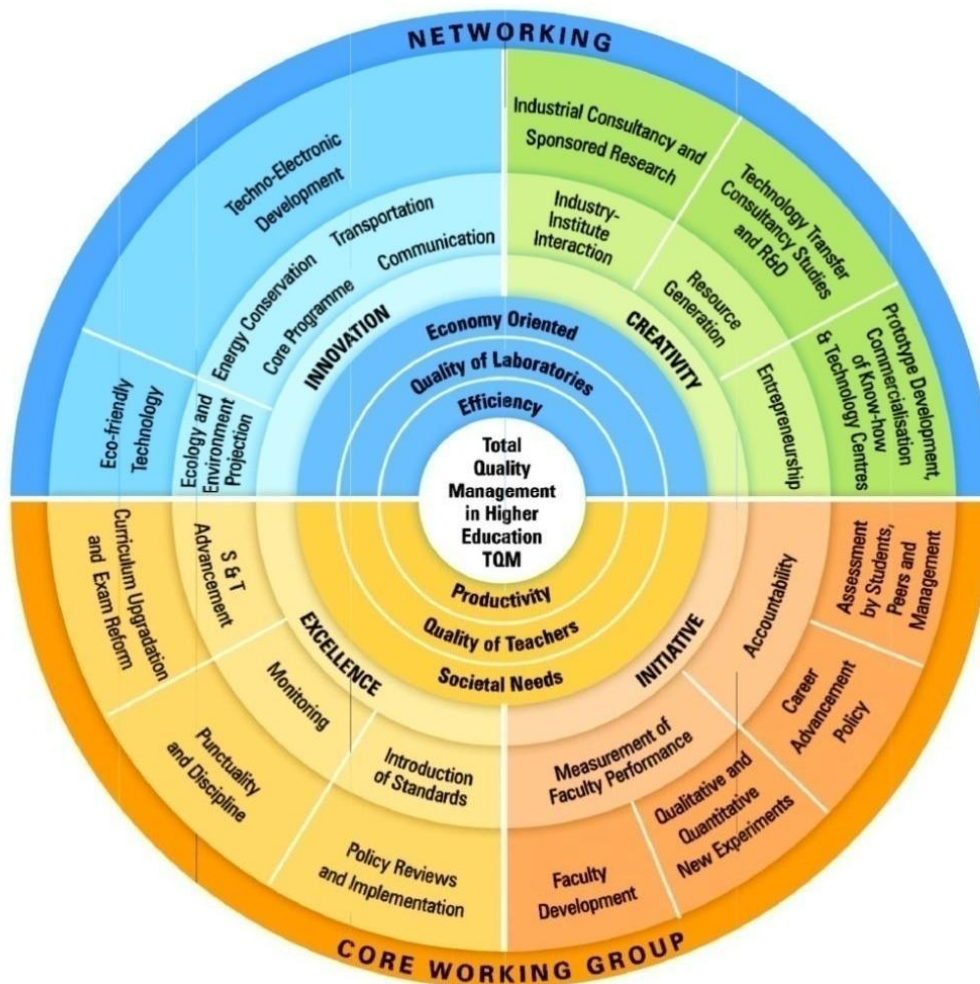

A conceptual model for the Total Quality Management(TQM) framework through which DEI endeavours to achieve quality in Higher Education (Professor P.S. Satsangi, 2002,‘TQM in Higher Education and Technical Education’)

Six Sigma: A Six Sigma Approach has been framed by the Most Revered Chairman, Advisory Committee on Education, Prof. P.S Satsangi Sahab. This model represents innovation in technology to nurture quality in the following areas in order to foster a sustainable way of life:

- Quality and Inclusive Education
- Air Quality Monitoring: Air quality is continuously monitored; measures are adopted to improve the quality of air such as ban on use of vehicles in the campus, use of solar power, planting more and more trees in and around the campus.
- Water Quality Monitoring: Special effort is being made to prevent water pollution. Regular testing of potable water is done. Water storage tanks are disinfected periodically.

- Quality healthcare accessible to all
- Technological interventions growth in Agriculture and Dairy sectors
- Value Education & Women's Empowerment

All the above mentioned Six Sigmas are engrained in the Education System of our Institute. DEI encourages students and teachers to innovate and create solutions to improve quality of life of the common man who is the last link in the social chain. Six areas so identified, together can improve the quality of life of a commoner thus transforming our social system.

Since 14th September, 2013 the Institute is being meticulously guided with a visionary zeal under the leadership of its Director.

ORGANIZATIONAL STRUCTURE

The top administration of the Institute consists of the following:



President
Shri Prem Prashant
I.A.S. (Retd.)



Director
Prof. P.K. Kalra
M.Tech., Ph.D.



Registrar
Prof. Anand Mohan
M.Sc., Ph.D., F.N.A.Sc., F.A.Sc.



Treasurer
Smt. Sneha Bijlani
M.Sc., I.R.S (Retd.)

• Administration:

- Administrative Officer (Computers): Mr. H. K Khanna, M.Sc.
- Assistant Registrar (Administration): Mr. C.B.S Yadav, M.A
- Assistant Registrar (Academic): Mr. Gur Sewak Singh, B.Com
- Assistant Registrar (Accounts): Mr. S.D Verma, M.A

- **Administrative and Academic Bodies:**

- **Primary Body**

The Primary Body of the Institute consists of 25 members which includes the President (Chairman), Director, Treasurer, Deans of Faculties, six members nominated by the General Body of the Institute; a nominee of the Ministry of Education, Government of India; Secretary Education, U.P.; a nominee of the All India Council for Technical Education; one nominee each of the three educational societies, viz. the DEI Women's Training College Society, the DEI Engineering College Society and the Managing Committee of the Radhasoami Educational Institute of Agra; a nominee of the Dayalbagh Medical Relief Society, a nominated trustee of the Dayalbagh Educational Trust and two nominees of the President of the Institute. The Registrar is the ex-officio Secretary of the Primary Body. Generally, the Primary Body meets once every year.

- **Governing Body**

The Governing Body of the Institute consists of 15 members which include the Director (Chairman), Treasurer, two Deans from amongst the Faculty of the Institute by rotation; a nominee of the Ministry of Education, Government of India; a nominee of the Chairman, UGC; Director, Higher Education, U.P.; a nominee of the Academic Council of the Institute from amongst its members; a nominee of the Radhasoami Satsang Sabha, Dayalbagh; a nominee of the Managing Committee of the Radhasoami Educational Institute of Agra; a representative each of Industry and Agriculture of Dayalbagh nominated by the President of the Institute. The Registrar is the ex-officio Secretary of the Governing Body. The Governing Body meets as often as necessary.

- **Academic Council**

The Academic Council of the Institute consists of the Director (Chairman), Deans of Faculties; Heads/ In-charges of all the teaching departments in the University faculties, who are not Deans; members of the teaching staff of each faculty not below the rank of a lecturer who is not the Dean, Head or In-charge from each Faculty in order of seniority by rotation; Principals of all the non-University educational institutions; the Director of Technical Education, U.P.; a nominee of the Chairman, U.G.C.; two specialists in industry nominated by the Governing Body; and five eminent members in the field of Arts and Culture, Commerce, Education, Engineering and Science nominated by the Governing Body. The Registrar is the ex-officio secretary of the Academic Council. The Academic Council meets as often as necessary.

- **Finance Committee**

The Finance Committee of the Institute consists of the Director (Chairman), Treasurer, a nominee of the Department of Finance, Government of U.P. and two nominees of the Governing Body, one of whom is a Dean and a nominee of the U.G.C. The Registrar is the ex-officio Secretary of the Finance Committee. The Finance Committee meets at least twice a year.

- **Managing Council for Non-University Technical Educational Institutions**

The Managing Council for the Non-University Technical Educational Institutions consists of the Director (Chairman), Treasurer, Principals of the non-University technical educational

institutions, one teacher from the non-University technical educational institution not below the rank of lecturer by rotation in order of seniority, two nominees of the Governing Body from its members; Director, Technical Education U.P., one nominee of the Northern Regional Office, A.I.C.T.E., one nominee of the Managing Committee of the Radhasoami Educational Institute. The Registrar is the ex-officio Secretary of the Council.

- **Managing Council for Non-University General Educational Institutions**

The Managing Council for the Non-University General Educational Institutions consists of the Director (Chairman), Treasurer, Principals of the non-University general educational institutions, one teacher from the non-University general educational institution not below the rank of teacher by rotation in order of seniority, two nominees of the Governing Body from among its members; Director, Secondary Education, U.P.; one nominee of the Ministry of Education; one nominee of the Managing Committee of the Radhasoami Educational Institute of Agra; one nominee of the DEI Prem Vidyalaya Society, Agra; one nominee of the DEI Higher Secondary School Society, Agra and two eminent persons, not members or employees of the Institute, nominated by the President. The Registrar is the ex-officio Secretary of the Council.

- **Board of Studies / Faculty Board**

The Board of Studies consists of the Head of the Department as Chairman, all Professors of the Department, one Reader and two Lecturers and external expert(s). There is a duly constituted Faculty Board for each Faculty. It comprises all the Professors and Heads of Departments of the Faculty and two external experts, with the Dean as the Chairman. The recommendations of the Board of Studies regarding revision of syllabus and /or new courses approved by the Faculty Board are placed before the Academic Council of the Institute before implementation. The Faculty Boards meet at least once every year.

- **Research Degree Committee**

The Research Degree Committee closely monitors issues related to research work leading to the award of the Ph.D. degree. The members include the Director, concerned Dean, Head of the Department, and two external experts in the subjects. The supervisor of the candidate is the co-opted member of the Committee.

In addition to Deans of various Faculties, DEI has the following posts:

- ❖ Dean, Post-Graduate Studies & Research
- ❖ Dean, Under-Graduate Studies
- ❖ Deans, DEI-ICT Distance Education Centres
- ❖ Officer on Special Duty (Amenities, Beautification and Core Courses)

STAFF AND STUDENT STRENGTH

STAFF AND STUDENT STRENGTH AND COMPOSITION

(Information as on 30-06-2017)

STAFF

Teaching Staff (Working)

GN	-	190	
OBC	-	37	
SC	-	25	
ST	-	4	
Minority	-	7	-
Total	-	263 *	

***Professor 83 + Associate Professor 30 + Assistant Professor 142 * + Guest Teacher 08, Male 131 + Female 132**

(Working = Permanent + Temporary + Contract)

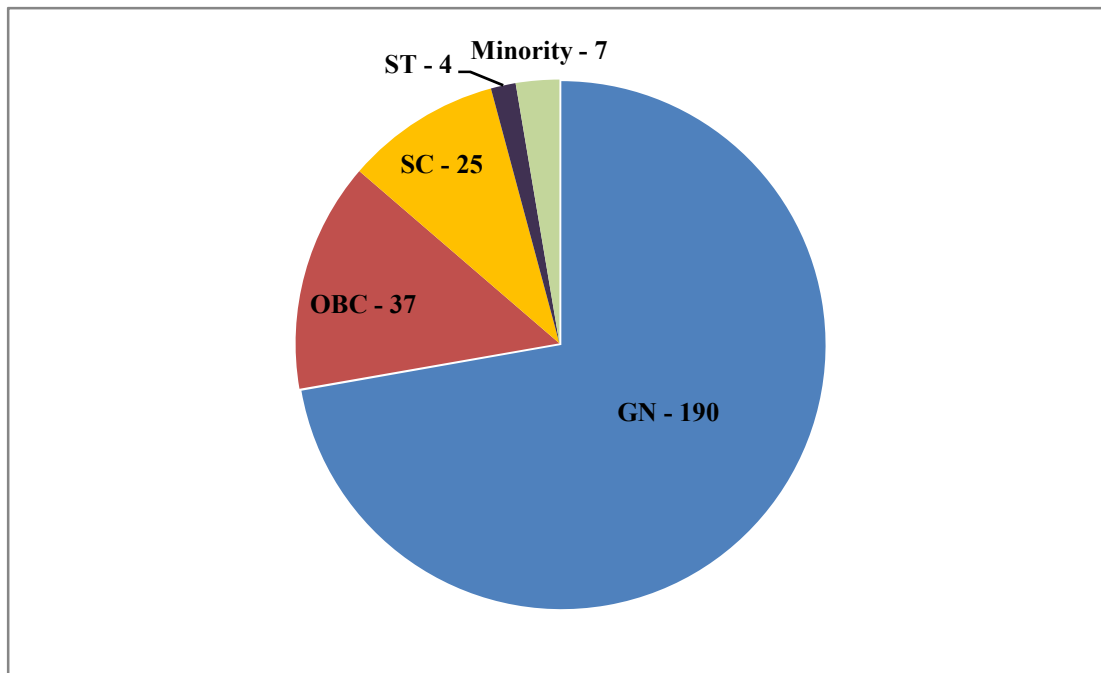

Dayalbagh Educational Institute (Deemed University), Agra

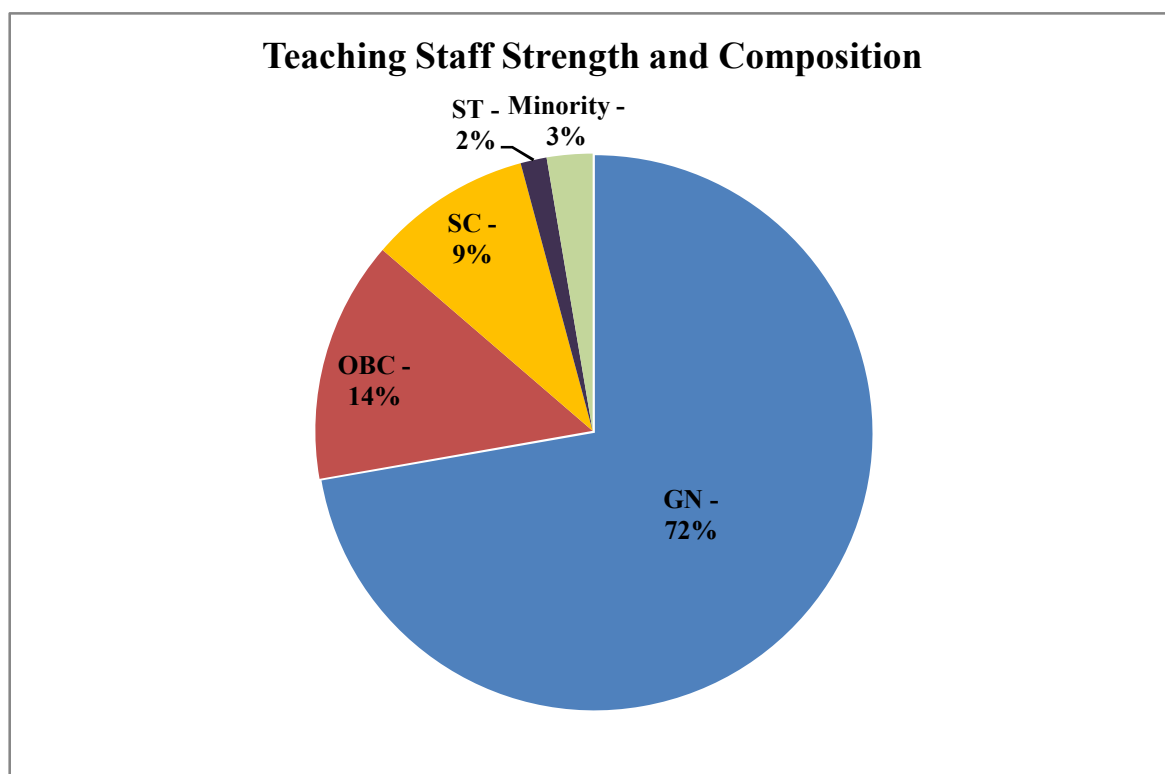

The table and diagrammatic representation show the total faculty strength in DEI is 263. Out of which 83 are Professors, 30 are Associate Professors, 142 Assistant Professors and 8 are Guest Teachers. Gender disaggregation indicates that 132 of the faculty members are women while 131 are men. Disaggregating for social class/ caste, we find 72% are General category, 14% are OBC, 9% are SC, 2% are ST and 3% are minorities.

Non-Teaching Staff (Working)

GN	-	118
OBC	-	72
SC	-	54
ST	-	05
Minority	-	08
Total	-	257 (Male-221 +Female 36)

(Working = Permanent + Temporary + Contract)

Annual Report 2015-16

CATEGORY WISE DISTRIBUTION OF STUDENTS

Student Strength in Institute/Departments																					
Category	General						SC	ST						OBC	*PH			Total Students			
Enrolment																					
1	2			3			4			5			6			T (2+3+4+5+6)					
	M	W	T	M	W	T	M	W	T	M	W	T	M	W	T	M	W	T			
UG	872	1412	2284	272	463	735	45	405	85	529	668	1197	14	10	24	178	13	27	40		
PG	673	273	340	192	92	111	04	060	10	344	19	183	03	07	10	124	52	04	64		
M.Phil/ M.Tech	39	71	110	12	15	27	01	01	01	16	27	43	00	00	00	68	11	3	18		
Ph.D	892	246	335	356	46	81	03	025	05	41	95	136	01	02	03	168	38	9	57		
Certi./Diploma/ P.G Diploma	32	59	91	67	7	13	01	01	01	16	18	34	00	01	01	55	84	13	9		
Total	1099	2061	3160	344	63	967	54	482	102	636	957	1593	18	20	38	2133	3689	52	22		
Category	GN						SC						ST			OBC			Total		
Distance Education							335						76			10111			2796		
B.Voc							100						5			222			704		
GT							435						81			1233			3500		

* Figure of PH students is included in General/SC/ST/OBC categories.

Please note that students' enrolment (2721) in non-university programmes (School 10+2 Standard and 3 Years Diploma) of the Institute, funded by U.P State Govt., is not included in the figure shown above.

M = Men W = Women T = Total

Result:

- The result of Under-Graduate level in the session 2016-17 was 97.75% - 100%.
- The result of Post-Graduate level in the session 2016-17 was 100%.
- The result of M.Phil level in the session 2016-17 was 100%.

List of Students Recipient of Medals (2016-17)

- The President medal was awarded to 02 students (01 Under Graduate level, 01 Post Graduate level)
- The Director’s medal was awarded to 81 students in UG & PG level.
- The Doctor of Philosophy degree was awarded to 73 students in the session 2016-17

PLACEMENT IN JOBS

S. No.	Companies	Electrical	Mechanical	Civil	M.Tech. /M.Sc.	Total
1	TCS	29	7	5	17	58
2	Maruti Suzuki	2	3			5
3	Lava International					
4	Crompton Greaves	4	7			11
5	Fiat India	1	1			02
6	M Supply	1				01
7	Torrent	3		2		05
8	Sunsure Energy	3		2		05
9	NLMK	1	5			06
10	PNC Infratech Ltd, Agra					
11	HCL	4				04
12	Tata Projects			6		06
13	Sports Flash	2	2			04
		50	25	15	17	107

PROGRAMMES OF STUDY OFFERED

DEI caters to the educational needs of the society right from pre-primary to doctorate degree level. It provides pre-nursery, primary, secondary, senior secondary, undergraduate, post graduate and research degree education to all sections of the society.

Levels of Education

- Ph.D.
- M.Phil.
- PG
- UG
- Senior Secondary
- Diploma
- Certificate
- Primary
- Pre-primary
- Nursery
- Pre-Nursery

Type of Education

- General- Conventional
- Practical
- Work-Based
- Vocational
- Technical
- Informal

Form of Education

- Integrated
- MEME

Mode of Education

- Direct
- Synchronous
- Distance

5.7 MODEL FOR VERTICAL AND HORIZONTAL PROGRESSION AMONG VOCATIONAL, GENERAL AND TECHNICAL EDUCATION IN DEI

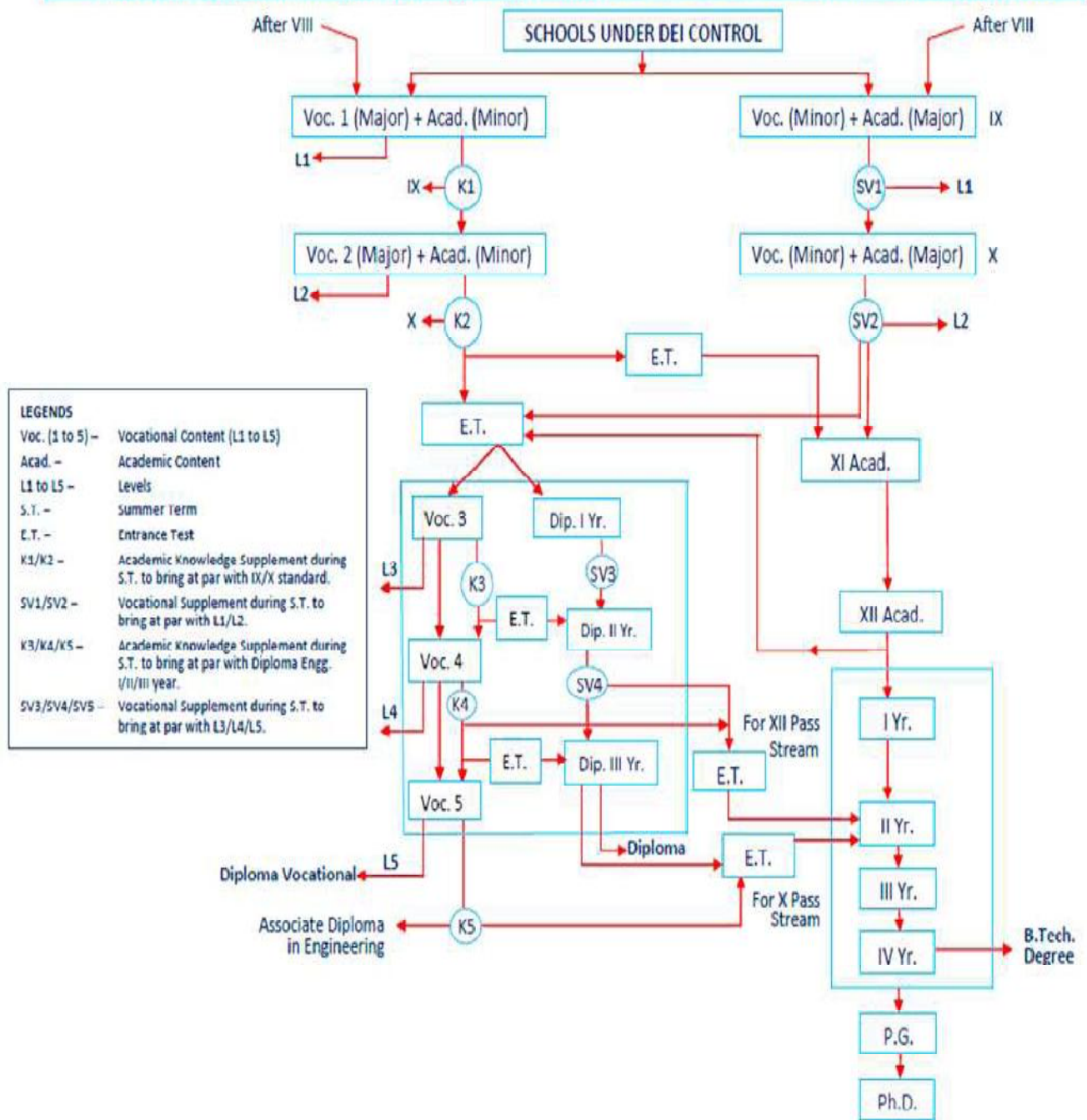

STRUCTURAL REPRESENTATION OF SOME OF THE INTEGRATED POST GRADUATE PROGRAMMES

INTEGRATED MBA PROGRAMME*

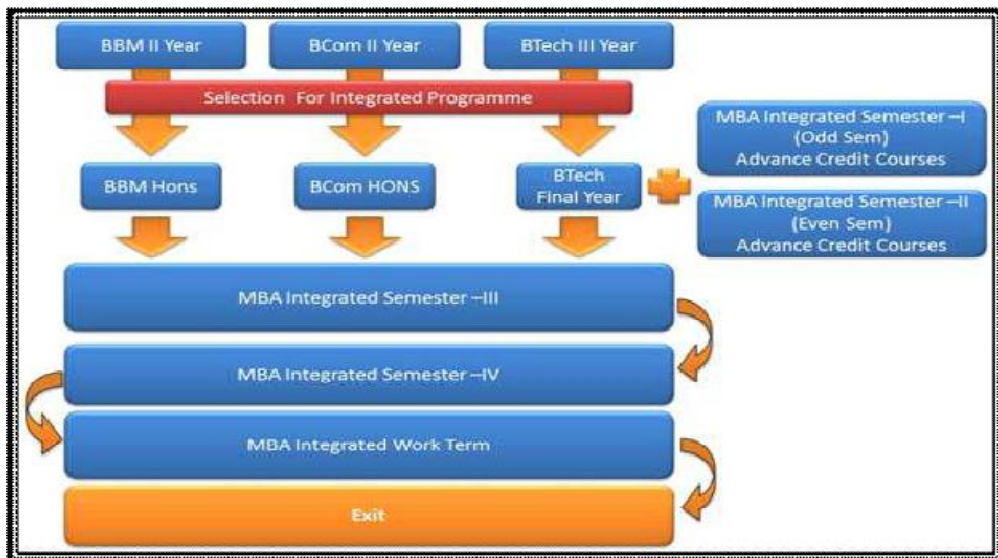

*Subject to fulfilling the eligibility criteria at successive stages

INTEGRATED BBM (HONS) WITH MBA, MPhil AND PhD*

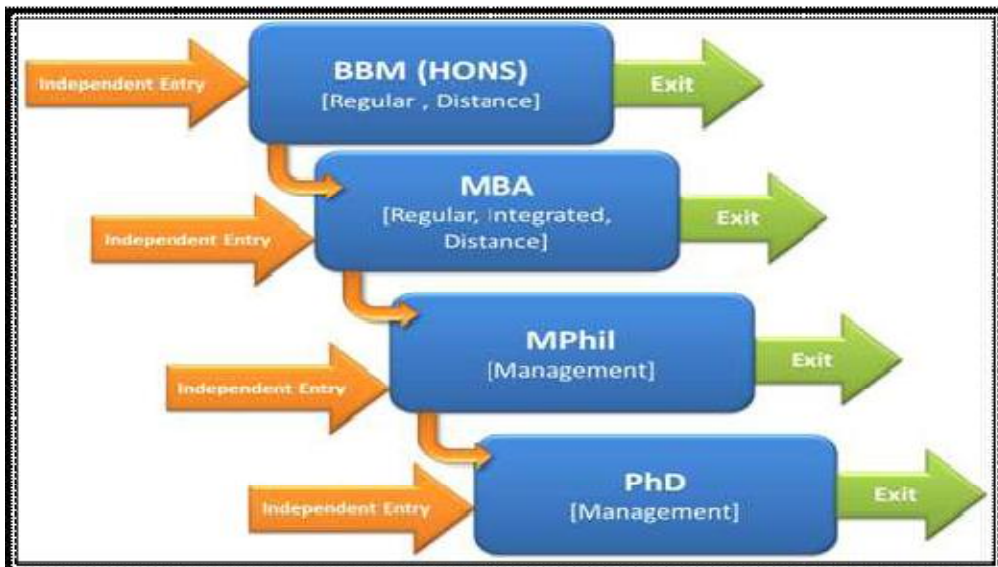

*Subject to fulfilling the eligibility criteria at successive stages

INTEGRATED BSc (HONS) M.Sc-MTech IN COMPUTER SCIENCE*

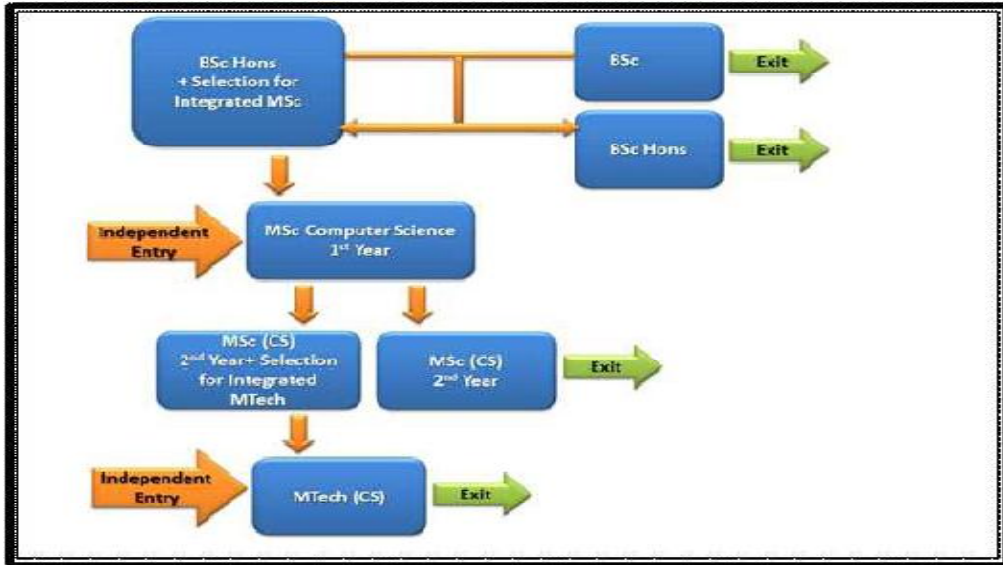

*Subject to fulfilling the eligibility criteria at successive stages

INTEGRATED PGDBE MA (APPLIED ECONOMICS) MPhil (ECONOMICS)*

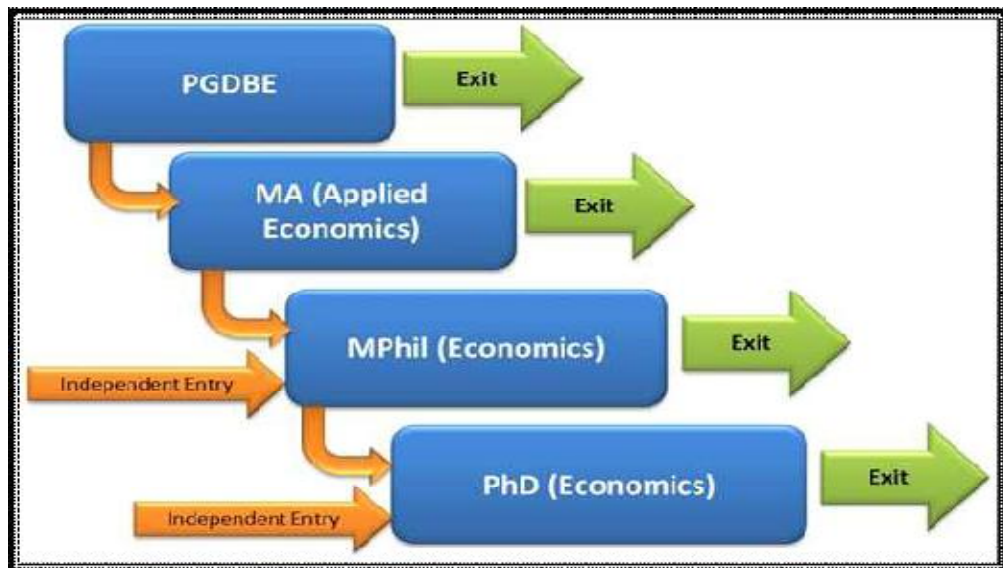

*Subject to fulfilling the eligibility criteria at successive stages

INTEGRATED PGDT MA-MPhil-PhD PROGRAMME IN THEOLOGY*

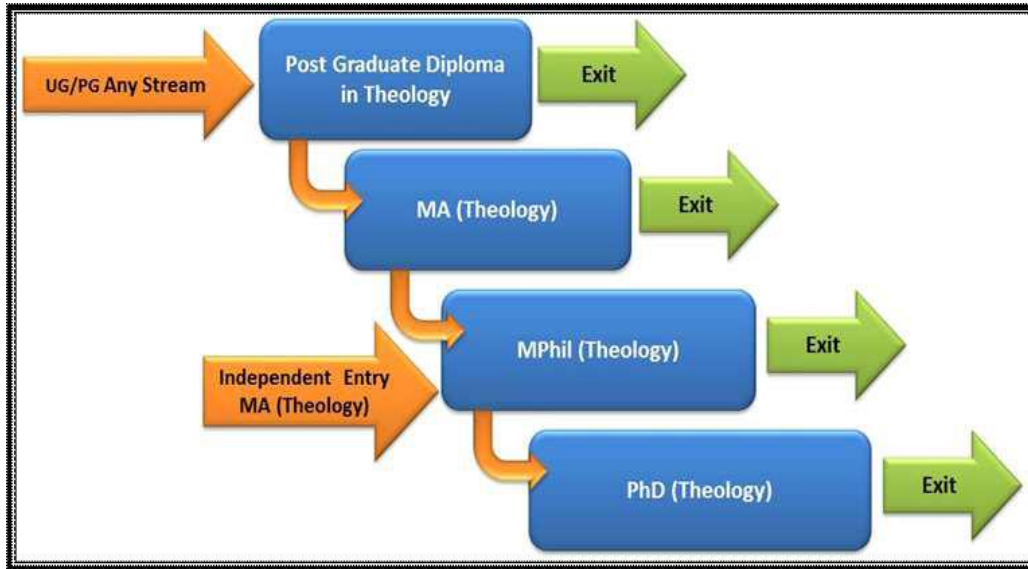

*Subject to fulfilling the eligibility criteria at successive stages

BACHELOR OF TECHNOLOGY IN FOOTWEAR & PART TIME

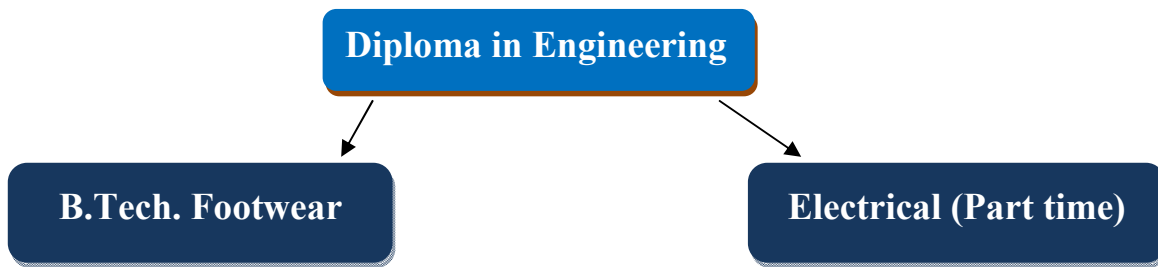

BACHELOR OF VOCATIONAL IN FOOD PROCESSING AND PRESERVATION & IN APPAREL MANUFACTURING*

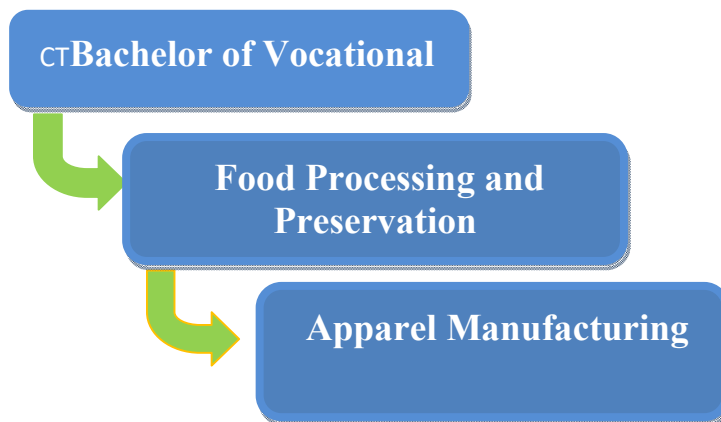

*Subject to fulfilling the eligibility criteria at successive stages

COMMUNITY COLLEGE DIPLOMA IN AUTOMOBILE

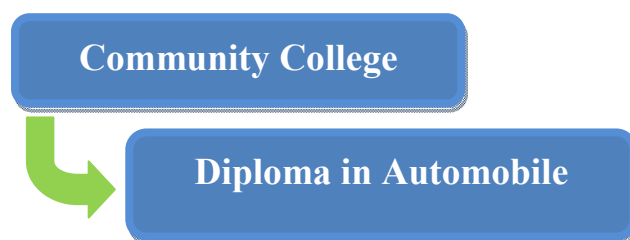

*Subject to fulfilling the eligibility criteria at successive stages

VOCATIONAL DIPLOMA IN AUTOMOBILE & INFORMATION TECHNOLOGY

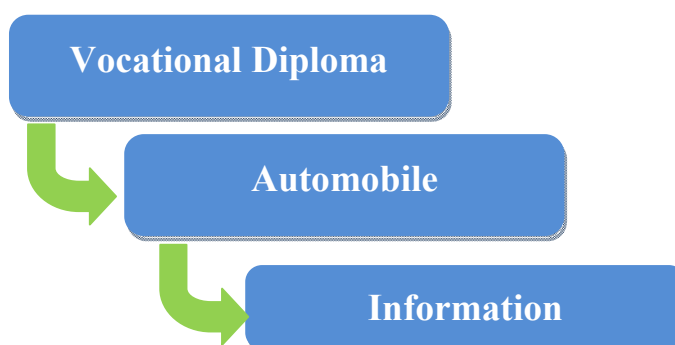

*Subject to fulfilling the eligibility criteria at successive stages

NEW PROGRAMMES OFFERED

S.N	Name of Course	Faculty	Semester/Modules
1.	B. Architecture	Faculty of Architecture	8 Semester
2.	P.G. Diploma in Human Rights and Social Works	Faculty of Social Sciences	4 Modules
3.	P.G. Diploma in Urban Planning	Faculty of Social Sciences	4 Modules

*PV: The increased demand for admission at High school and Intermediate level, a new section each for class VI, IX(Arts) and IX(Science) was started in the session 2017-18 in Prem Vidyalaya Girls Intermediate College.

Interactive Tablet Based Teaching Learning System

The Faculty of Education has initiated a tablet based Teaching Learning programme for school students and teachers in remote areas and under-resourced schools. The twin objectives are to

provide quality education to the underprivileged as well as to provide state of the art online teaching experience to the intern-teachers of the Faculty. The key feature of the system includes enhancing interaction between the teachers and learners in the online mode using various modes like audio, video, chat, polling questions, blackboard sharing and e-content sharing. At present the programme has been launched in secondary schools of Timarni and Rajaborari in MP. It is planned to extend the programme to remote areas in Tamil Nadu (MTV Puram) and Bihar (Murar).

CONTINUOUS EVALUATION & GRADING SYSTEM

The academic progress of students registered under different programmes is evaluated continuously

- 1) The Institute follows the credit system of evaluation. Each course is allotted definite credits in proportion to the expected time devoted by the candidates in that course.
- 2) Based on their academic performance, students are graded on a 11 point scale. A description of the grades, corresponding grade values, the achievement level and the procedure for calculation of SGPA is as follows:

$$SGPA = \frac{GP_1 \times C_1 + GP \times C_2 + \dots + GP_n \times C_n}{C_1 + C_2 + \dots + C_n}$$

The overall performance of all the semesters for a given programme is given as Cumulative Grade Point Average (CGPA) which is calculated in a similar way for the subjects studied during the entire course. Multiplication of CGPA by 10 yields the equivalent percentage marks gained by a student.

- 3) Award of Division: The minimum CGPA for different division is given in the following table and is common for both PG and UG programmes.

S.No.	Division	CGPA
1	First with distinction	8.5
2	First	6.0
3	Second	3.0

DISTANCE EDUCATION

1. Introduction

The Distance Education Programme of DEI was launched in the year 2004 to extend the benefits of its high quality, innovative, value-based and affordable education to all sections of society, especially the weaker sections and women residing in remote, backward and tribal areas. Aimed at their empowerment and economic development, a number of employment-oriented vocational programmes are offered with very nominal fee mainly to meet the cost of the resource material, which is made available free to students. In addition, higher level programmes are also offered.

DEI's Distance Education Programme has the approval of the erstwhile Distance Education Council (DEC, IGNOU). On the recommendation of the Joint Committee of UGC-AICTE-DEC, recognition had been accorded to a number of programmes to be conducted in distance mode.

With the abolition of Distance Education Council, UGC became the regulator of Distance Education. It decided to maintain status quo and the recognition accorded earlier by the Joint Committee to the programmes was extended to the academic year 2014-15 and then to 2015-16. Following this, UGC invited proposals for recognition for 2016-17 and a detailed proposal in four parts (parts A,B, C and D) was submitted for recognition of DEI as a Distance Education Institute and for the programmes which had already been recognised for being offered in 2015-16. A presentation was made before the UGC panel and recognition was awarded to DEI to offer all the proposed programmes during the academic years 2016-17 and 2017-18.

2. Programmes Currently Offered in Distance Mode

(i) Certificate Programmes (1-2 years) : All in Modularized format

- i. Modern Office Management & Secretarial Practice (and its close variant :Office Assistant-cum-Computer Operator)
- ii. Textile Designing & Printing
- iii. Textile Technology
- iv. Dress Designing & Tailoring (and its close variant: Cutting & Sewing)
- v. Motor Vehicle Mechanic (4-wheeler/2-wheeler)
- vi. Wireman
- vii. Electrician

(ii) Under-Graduate Degree (3 years)

- B. Com (Hons)
- BBM (Hons)

(iii) Post-Graduate Diploma (1 year)

- Theology
- Journalism & Mass Communication
- Computer Science & Applications

(iv) Post-Graduate Degree

- MBA (3 years) (in modularized format)

3. Enrolment Data and Student Profile

In the academic year 2016-17, a total of 2367 students took fresh admission in the programmes listed above. The number of senior students (2nd and 3rd year) was 594. Thus the total enrolment in DEI-DEP was 2961.

The data on student profile for the academic year 2016-17 is shown below in terms of gender (male – female), Category (General and Reserved), and area (Urban – Rural) with the help of Pie diagrams.

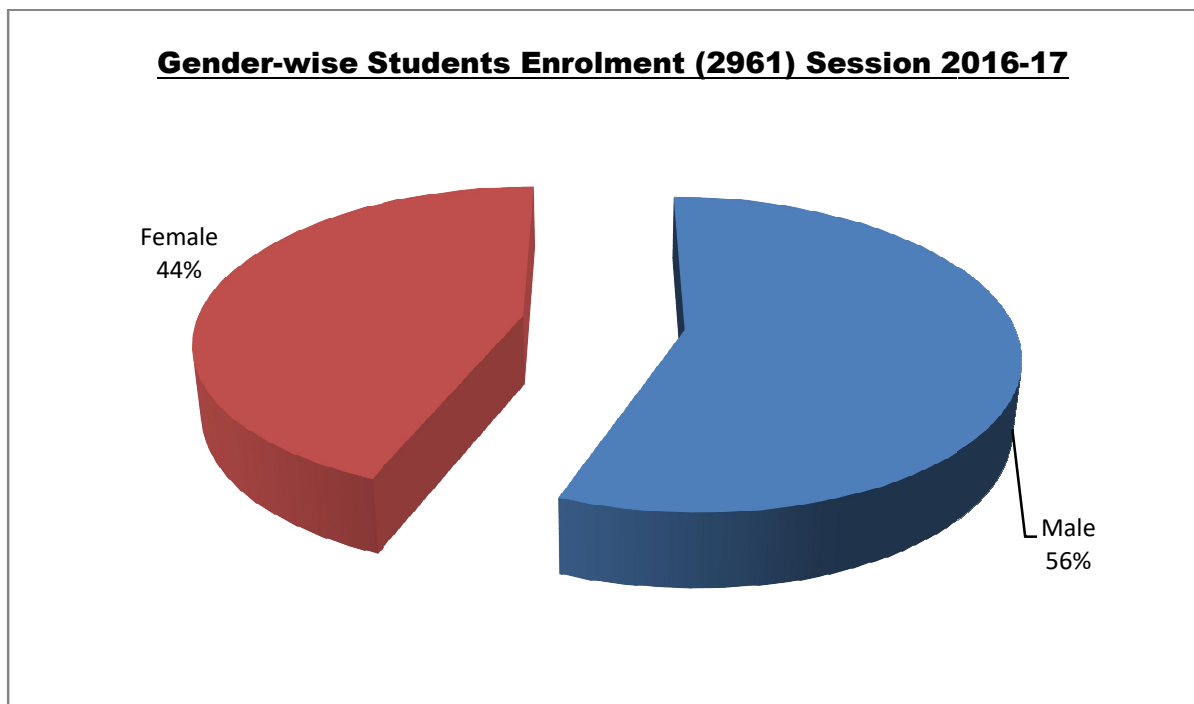

Category-wise Student Enrolment (2961) Session 2016-17

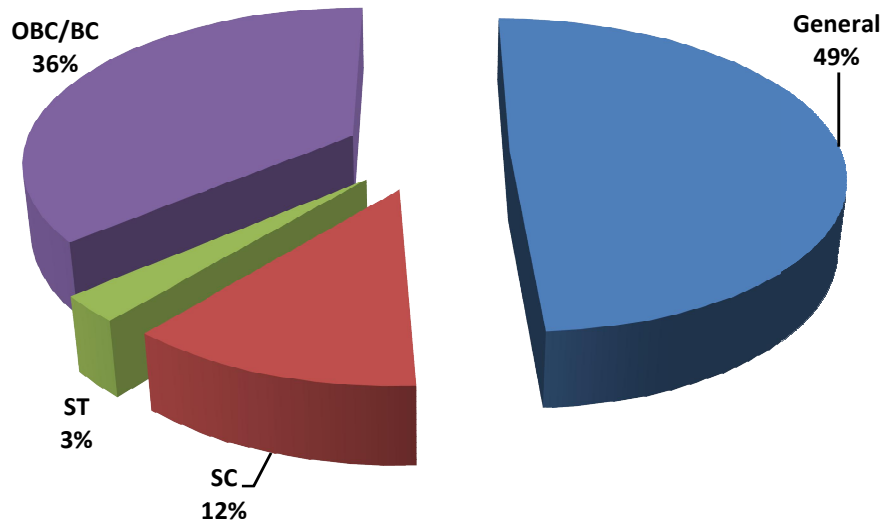

Area-wise Student Enrolment (2961) Session 2016-17

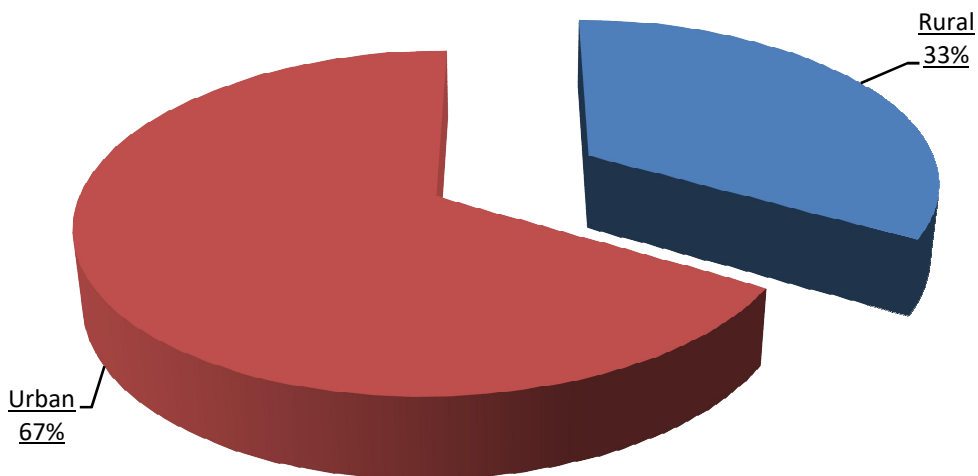

The diagrams presented above clearly demonstrate that the objectives of the Distance Education Programme of DEI are being met to a substantial degree and the benefits of DEI's quality education and training via the distance mode are reaching the economically weak persons in remote areas, especially women who did not have access, hitherto, to quality education at affordable cost or even free of cost.

4. DEI Information Centres

As shown in the map given below, in the academic year 2016-17 DEI had 90 centres spread over the length and breadth of the country.

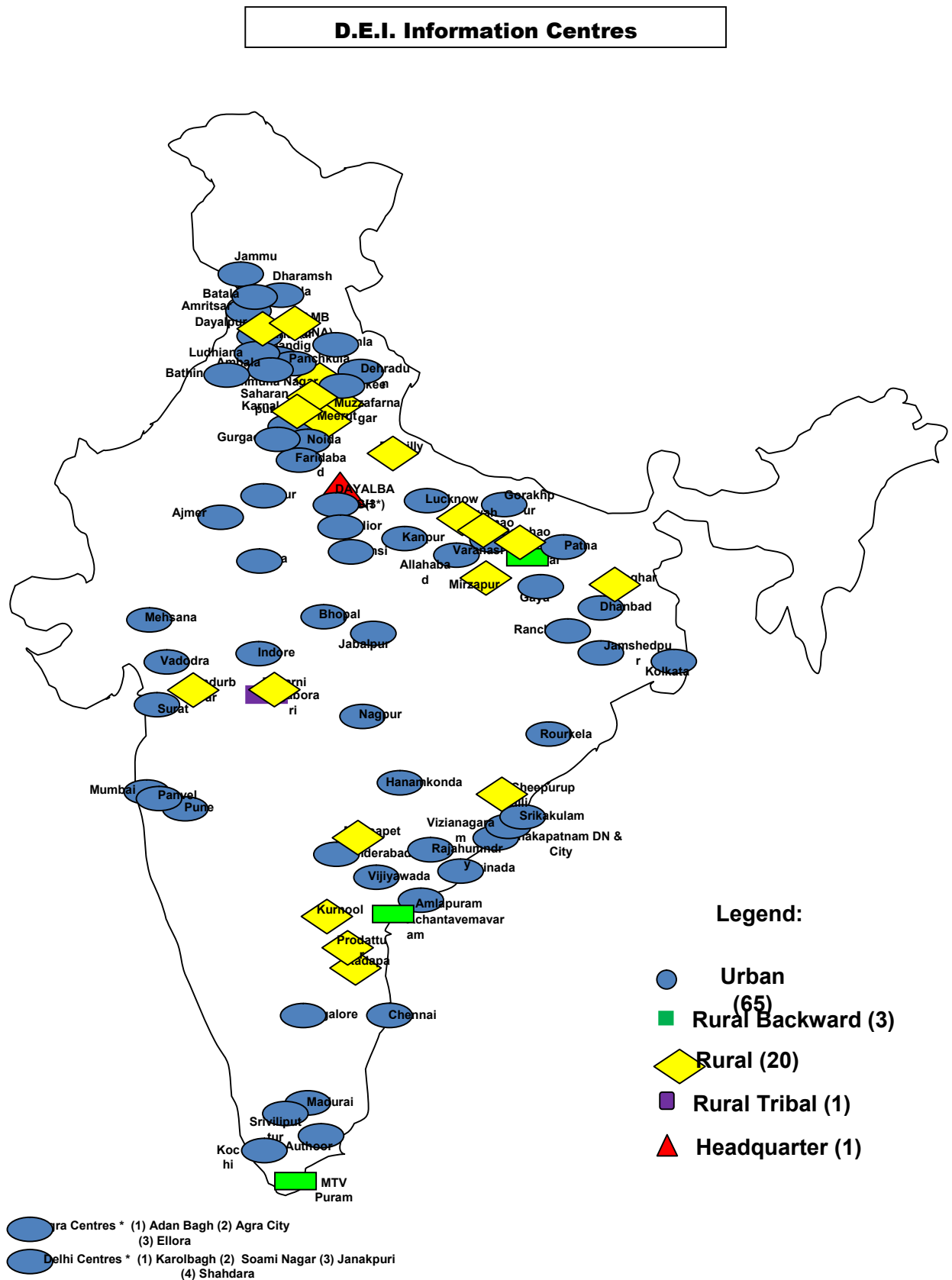

5. Student Enrolment : State-wise and Programme-wise

(a) State-Wise Student Enrolment (2961) for 2016-17

The state-wise distribution of students is shown below:

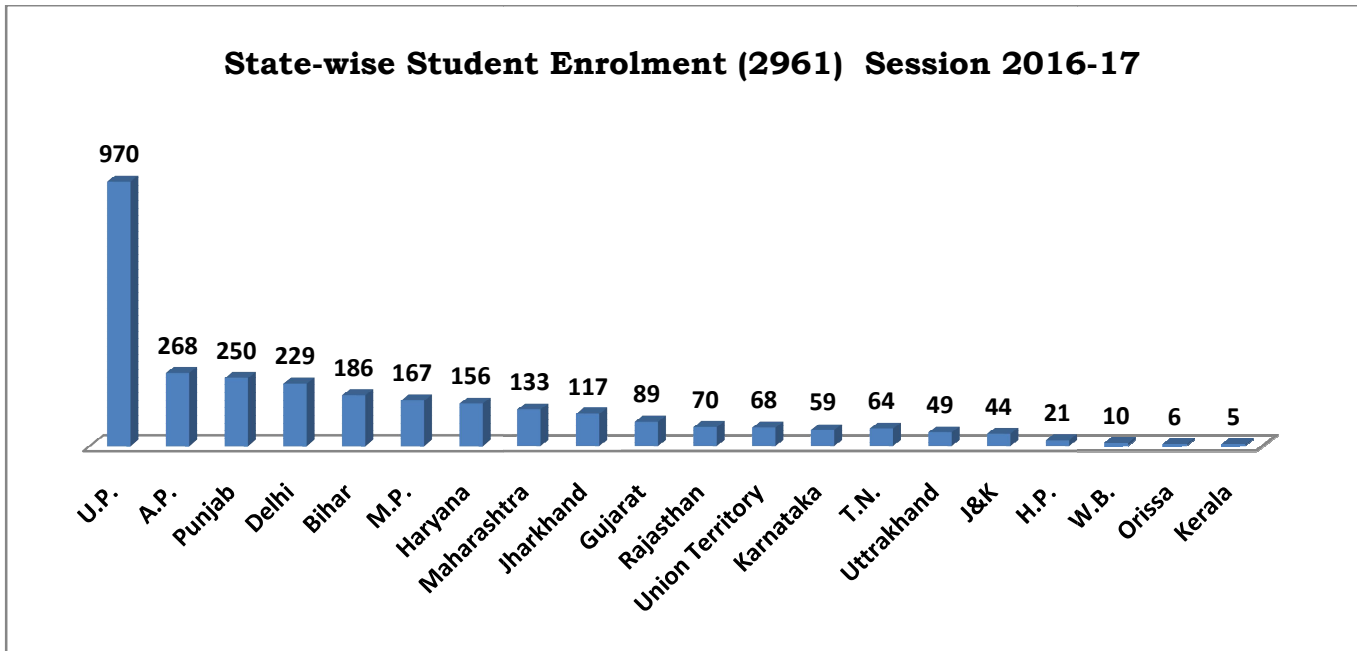

The trend shown is similar to that shown in previous years with UP in the lead. However, while U.P. has shown an improvement in student numbers, AP in position two shows a decrease compared to previous years in spite of two new centres being added this year.

(b) Programme-Wise Student Enrolment for 2016-17

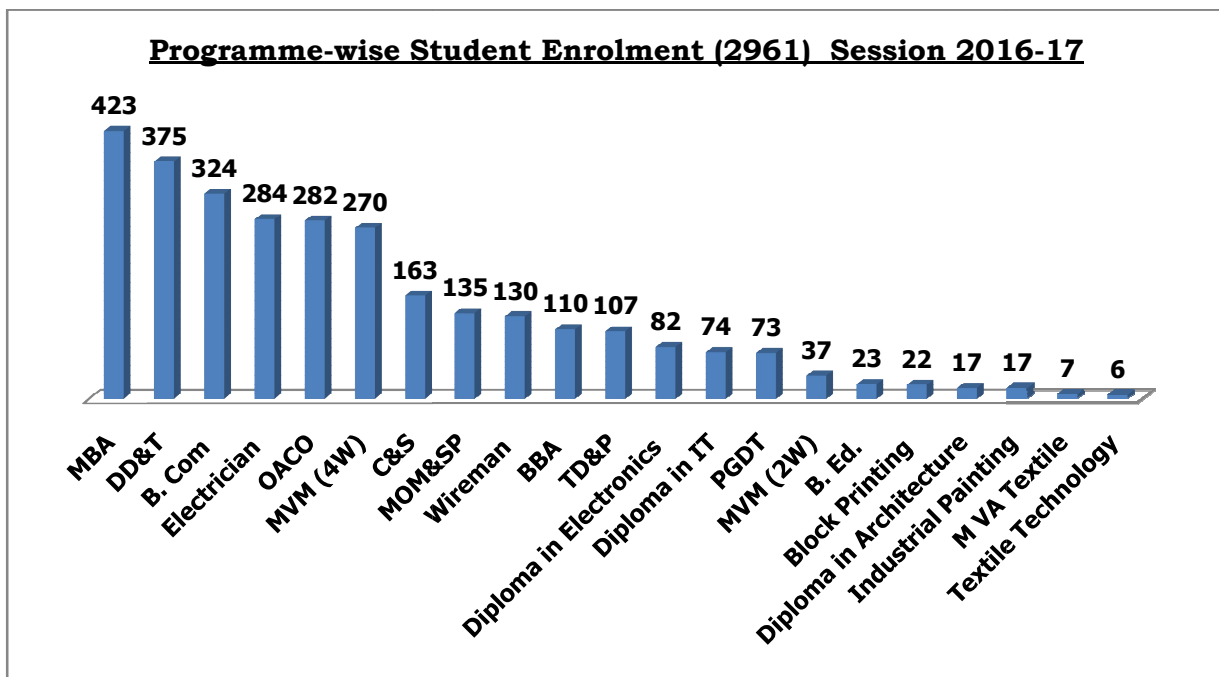

6. Some Initiatives

(i) Course Material Developed for New Certificate Programmes

Certificate level course material in modularised format has been developed on *Installation & Maintenance of Solar Electric Systems*.

Another Certificate course on 'Electronics Mechanic' is being developed. Both these courses are likely to be offered in the distance mode with effect from the 2017-18 academic year.

(ii) Self-employment and Entrepreneurship

The Distance Education Programmes are need and employment-oriented. In the Certificate level programmes and in the B. Voc based programmes, emphasis is on self-employment and on establishing an industry by self-enterprise whereby one can provide employment not only to oneself but provide employment to others also. The various steps needed for entrepreneurship are embedded in the education system itself.

7. DEI ICT Centres

The Dayalbagh Educational Institute has established six ICT Centres at various rural and urban locations across India. Diploma, degree and higher level programmes are offered in synchronous mode through state-of-the-art Information and Communication Technology (ICT) to students admitted to the DEI, with the flexibility to attend classes at these multiple locations. The rural centres are at Murar (Bihar), Melathiruvenkatanathpuram (Tamil Nadu) and Timarni-Rajaborari (MP) whereas urban centres are located in Amritsar, Bengaluru and New Delhi.

The courses being offered at present at these ICT centres in the synchronous mode include degree courses, like B. Ed, MBA, M.Tech, M. Phil, Ph.D and PG Diploma in Journalism & Mass Communication. Students were admitted to these courses through the centralised DEI admission process.

INSTITUTE FINANCE

INSTITUTE FINANCE

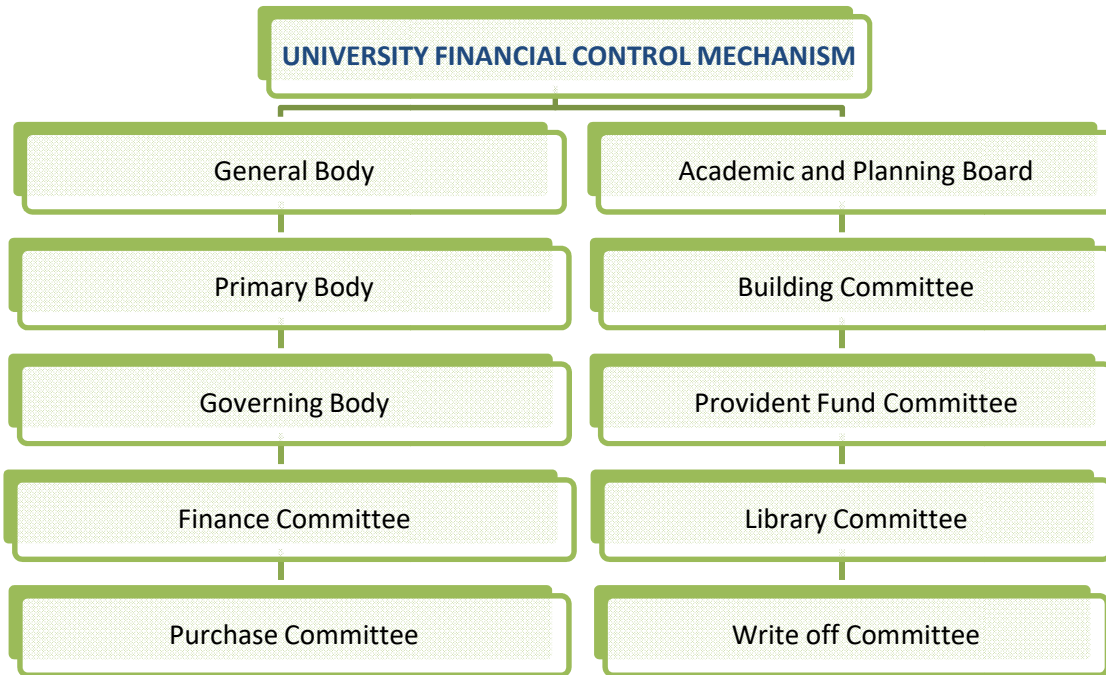

INSTITUTE FUNDS

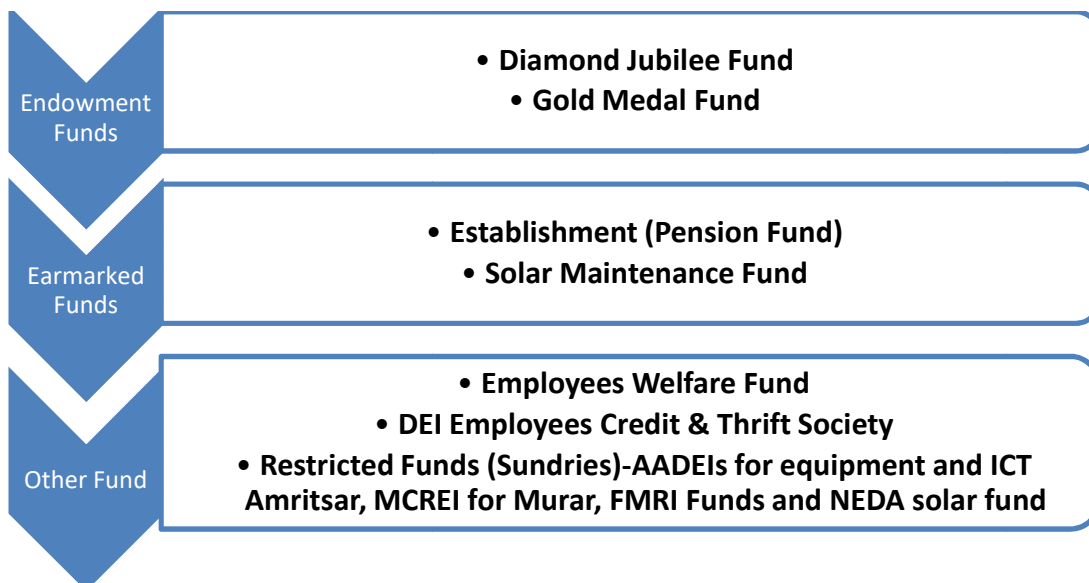

MAIN SOURCE OF INCOME	
1.	UGC- Plan & Non Plan (Maintenance Salary and Non salary)
2.	UP Government (Salary)
3.	MHRD, DST,AICTE,CSIR, DAE, ISRO, DIT,ADRDE, DRDO,PCRA,ICSSR(Research Grants)
4.	Other Sources of Income <ul style="list-style-type: none"> • Fees • Income from interest • Contributions by trust • Contributions by Alumni Associations • Income from Consultancy • Income from sales and services • Overhead charges from projects

During the financial year 2016-17 the UGC sanctioned Rs 2942.80 lakh as Maintenance Grant and Rs. 440.26 lakh as Plan Grant. The UP Government sanctioned a grant of Rs 1734.86 lakh as regular salary grant and Rs. 10.15 lakh for the National Service Scheme. The income from investment from non-government sources amounted to Rs 654.71Lakh.

a. Unit Cost: The Unit Cost was Rs. 12703/- (Without Salary)

b. Progress In Research

There are 19 ongoing projects sanctioned by various agencies. A summary of the Projects is given below:

S.N.	Sanctioning Agency	No. of Projects	Amount Sanctioned (in Lakhs)
1.	DST	07	269.58248
2.	MHRD	07	112.92213
3.	UGC	02	73.2
4.	ICSSR	01	4.8
5.	AICTE	01	12.17647
6.	BRNS	01	24.48403
	TOTAL	19	497.16428

c. Fellowships and Scholarships

During the session 2016-17, 168 research scholars were distributed fellowship from various grants amounting to Rs.742.54446 lakhs under following schemes.

S.No	Sanctioned Agency	Number of Students	Amount	Payment Mode
1	UGC-Research Fellowship	1	376787	Institute
2	NET. Junior Research Fellowship	15	5204012	Institute
3	UGC-P.G.Scholarship to M.Tech Students	7	275578	Institute
4	Dr. Kothari Post Doctoral Fellowship	1	658000	Institute
5	NET. Junior Research Fellowship	25		DBT
6	National Fellowship for OBC	19		DBT
7	BSR Fellowship	11		DBT
8	Post Doctoral	4		DBT
9	Maulana Azad Fellowship	2		DBT
10	Rajiv Gandhi National Fellowship	29		DBT
11	Rajiv Gandhi National Fellowship	6		WEB PORTAL
12	Maulana Azad Fellowship	1		WEB PORTAL
13	BSR Fellowship	2		WEB PORTAL
14	NET. Junior Research Fellowship	11		WEB PORTAL
15	National Fellowship for OBC	3		WEB PORTAL
16	CSIR - Fellowship	3	720401	Institute
17	DST - Inspire Fellowship	12	2298377	Institute
18	ICSSR - Doctoral Fellowship	16	1693613	Institute
	Total	168	74254446	

CENTRAL FACILITIES

A. Central Library

The DEI has modern Central Library. Central Library was ISO 9001:2008 certified under support services (Bureau of Veritas Certification) on 2nd January 2017. The working hours of the central library are from 8.30AM to 5.00PM on all working days. The Central Library houses **183413** books and subscribes total 112 (90 National and 22 International) Journals and has 10625 reference books. Central Library has 137 rare books in its collection. Internet and E-Journals access facility has been extended to several computers in all faculties as well as Central Library. Institute is also subscribing DELNET to access engineering, science journals and other e-resources. The E –Journals (5000 approx.) consortium programme is providing e-journal access in all fields related to Arts,



Humanities, Social Sciences, Physics and Chemical Sciences, Life Sciences, Computer Science, Mathematics etc. Database from 17 publishers is also accessible at present. Central Library also purchased online Pro Quest Dissertation & Theses Abstracts Complete to facilitate its user. Central Library also provides scanning and printing services to its users. The transaction of the books is fully computerized with barcode system. The computerization has been achieved by the library staff on their own using open source software, called NEWGENLIB. Library has uploaded 240 theses and 370 synopses of Ph.D. on INFLIBNET site after plagiarism check under Shodhganga and Shodhgangotri programme of INFLIBNET (UGC).

B. USIC

Department of USIC comprises four workshops viz. Computer, Electronics and Mechanical (including refrigeration) & Glass Blowing. These sections are involved in repair and maintenance of laboratory instruments, computers & its peripherals, electronic and mechanical equipment. These sections also regularly conduct work- experience and short term courses.

USIC has established state of art Rapid Prototyping (RPT) Centre. The RPT centre is equipped with 3D scanner, 3D digitizer and 3D printers. The 3D printers are based on two well-known techniques viz. Fused Deposition Modeling and Polyjet Technology. In all four 3D printers are available of which three are Fused Deposition Modeling and one is based on Polyjet Technology. The objectives of the RPT centre are as follows:

- To provide facilities to the entire Institute community and stakeholders for refining existing products and developing new prototypes.
- To foster innovative skills among students and teachers in their areas of interest.
- To help students evolve as entrepreneurs with self-sustaining capabilities.
- To collaborate with Industries/Business partners to sponsor projects that provide hands-on training to students.
- To provide facilities to work with business partners/sponsors to address their specific needs.
- To focus on socially relevant products which will have impact on quality of life.
- To create a central facility for promoting interdisciplinary teaching, research and innovation.

Moreover, the RPT centre is actively involved in fostering the innovative skills among students. Second year Civil engineering girls from Faculty of Engineering completed their Product Manufacturing Project (PMP) course, in which they learnt designing in CAD based solidworks software and 3D printing of their respective models. The RPT centre is also involved in making working parts of the instruments received in USIC for repairs which are either worn out or broken.

Department of USIC is also engaged in the development of Robotics Laboratory. This lab will facilitate the students to design, build and automate various kinds of robots. Students of B.Tech., IInd year Electrical Engineering are developing 3D printed robots namely Spider robot, Robotic arm, Combat tank, Bi pedal robot and Omni wheel robot. The 3D printing, circuit designing and programming of these robots is entirely done by these students. Students of B.Tech. IInd year and IIIrd year Electrical Engineering are developing Autonomous Vehicle (Driverless Car) with features like automated path detection and obstacle avoidance system embedded in an electric vehicle.

Focusing on the needs of future, the Mechanical department of USIC is providing the students of Diploma in Automobile, Vocational Diploma in Automobile and B.Voc. in Automobile with the latest technology of Electric and Hybrid Vehicles. Students of Final year Diploma, Vocational Diploma and B.Voc. in Automobile have developed Electric Personal Mobility Vehicles (PMVs) such as Two wheeled Segway, Three Wheeled Segway, Hybrid Treadmill Bicycle and Hybrid Scooter.

The students while developing these models learned and got acquainted with various aspects of designing, 3D printing, programming and control of automotive electronic circuitry.



3D Printed Spider Robot



3D Printed Robotic Arm



Hybrid Treadmill Bicycle

USIC is also coordinating two undergraduate level B. Voc. courses namely Automobile and Water Sanitation and Solid Waste Management having 65 and 50 numbers of students in first year respectively. The objectives of the B. Voc. Course in Water Sanitation and Solid Waste Management are as follows:

- Develop an understanding regarding water crisis and its prevention.
- Skill development in waste water management.
- Create awareness of government schemes and projects related to sanitation and water management.
- To provide knowledge and skills on modern techniques in sanitation.
- To create deeper understanding status, problems and solutions of solid waste in India.
- To carry out waste audits.
- To develop skill in innovative techniques in waste management.
- To provide training and support to students to become entrepreneurs.



Dustbins with stand developed by B. Voc Waste Management students



Students preparing Organic Manure

Repair and maintenance of submersible motors is also one of the major activities of USIC. Full-fledged repair workshop is established to cater to the repair and maintenance of wide variety of models of submersible motors and pumps ranging from single H.P. single-phase motors to 35 H.P. three phase motors. This caters to the needs of the Institute & its surroundings.

USIC is also involved in community services of charitable institutions & hospitals around DEI. USIC undertakes repair & fabrication work at low cost. The work enables our staff to acquire skills which one would not be able to acquire doing normal Institute jobs. USIC fabricates low cost instruments.

USIC also offers one year certificate course on “MAINTENANCE & REPAIR OF MEDICAL & LABORATORY EQUIPMENT”. It is a practical based vocational course involving summer training.

USIC is also conducting two courses on Refrigeration and Office Equipment under Pradhan Mantri Kaushal Vikas Yojana (PMKVY). It is a skill development initiative scheme of the Government of India for recognition and standardization of skills. The aim of the scheme is to encourage aptitude towards employable skills and to increase working efficiency of probable and existing daily wage earners, by giving monetary awards and rewards and by providing quality training to them.

Besides the above activities, USIC faculty are involved in supervision of dissertation at Ph.D. & M.Sc. level & student projects at B.Tech., B.Voc. & Diploma level courses. Faculty & staff are also involved in interdisciplinary research work.

Jobs undertaken by USIC from 01 July 2016 to 30 June 2017 are as given below:

Workshop	No. of jobs received for repair	No. of jobs completed	No. of jobs completed with outside help	No. of jobs refused
Glass Blowing	27	27	None	None
Computer	552	552	None	None
Electronics	40	40	None	None
Mechanical	25	25	None	None

C. DEI SEMINAR COMPLEX AND CONTINUING EDUCATION FACULTY HOSTEL

A new Seminar cum Hostel Complex has been constructed for holding Seminars, Conferences, and important meetings. The hostel consists of 16 guest rooms, a seminar hall with 300 seating capacity, committee room and dining hall. The campus is equipped with wi-fi and networking facility.



D. CENTRE FOR APPLIED RURAL TECHNOLOGY

The distinguished feature of DEI's Education policy is its emphasis on combining excellence with relevance to contemporary needs of the society. The Center for Applied Rural Technology (CART) offers a large number of vocational courses through its Modular and Certificate level programmes. These programmes are employment oriented and are offered at a nominal fee. By creating livelihood opportunities, CART makes a valuable contribution to the economic development and self-help of the individuals. The Centre is well equipped with state-of-the-art facilities to train students adequately enabling their faster placement. The Centre is registered with All India Council for Technical Education (AICTE) and recognized as Skill Knowledge Provider (SKP) in the sectors of Automobile and Information Technology up to level 5 of National Skill Qualification Framework (NSQF).

INFRASTRUCTURE DEVELOPMENT

A. Construction of Building:

1. Construction of Multipurpose Gymnasium upto roof level.
2. Construction (addition & alteration) for establishing DEI Food Processing Outlet (i.e. DEI shop)
3. Construction of a battery room in DEI Footwear Workshop Building
4. Providing ramps in all the buildings of the Institute.
5. New boring done near Over Head Tank to augment supply of water.
6. Renovation of Food Processing lab.
7. Fencing around Bio Diversity Park.
8. Construction of a water tank in Bio Diversity Park and laying of pipeline to fetch water from canal to park.
9. Renovation of CAO

B. Internet Network:

1. A fully networked campus (Wired network) with a fibre optic backbone.
2. Fibre optic backbone has been extended to Tannery campus, International guest house and boys & girls hostels.
3. Ultra-Modern Multimedia Laboratory for content generation and distribution.
4. **Optical Fiber** network will have convergence of
 - a. **Security Surveillance**
IP Camera (250), Access Control
Central & Local Monitoring Stations with 24x7 Vigilance
 - b. **ICT based Education** –high speed connectivity to support disseminating DEI System of School Education worldwide
 - c. **Communication**–IP Phones (100) to provide alternate secured communication pathway
 - d. **Connectivity Backbone** -high speed connectivity to offices and institutions.
5. **Security Surveillance Dayalbagh Educational Institute**

Phase-1: Optical Fiber connecting DEI and its Institutions. (4 km underground, 4km aerial route)

- Mughal Road
- Jaganpur
- Nursery School
- DEI Computer Center
- Swet Nagar
- Saran Ashram Nagar
- Saran Ashram Hospital
- Dairy Farm / Botany Dept.
- Poyiaghat Road

Optical Fiber Layout for Security Surveillance Network – Phase 1 (inside Dayalbagh)

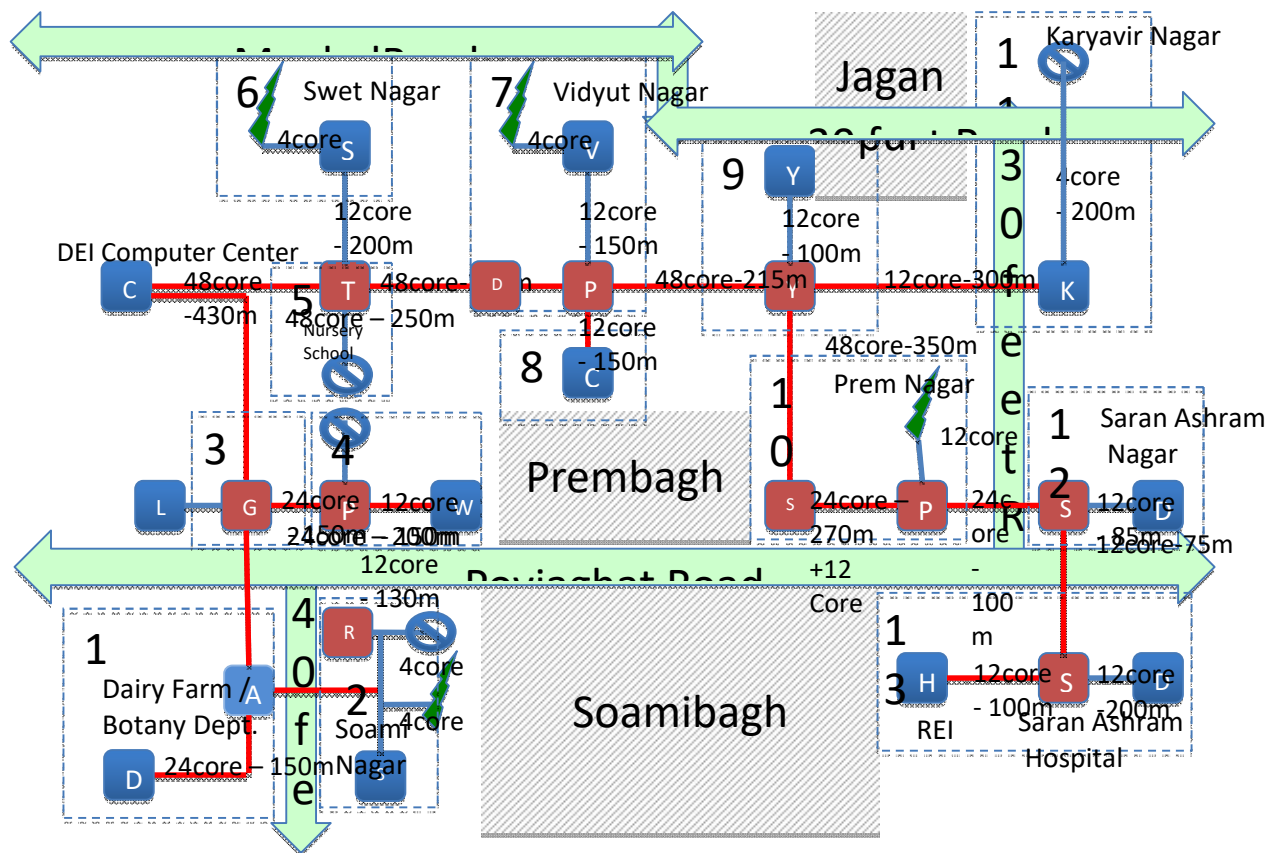

Phase-2: Optical Fiber connecting DEI and its Institutions. (3 km underground, 1km aerial route) Optical Fiber Layout for Security Surveillance Network

- International Seminar Hall
- Radhanagar
- Boys Hostel
- Engineering Faculty
- Girls Hostel
- CART and Leather Campus
- Library
- Workshop
- TC Workshops
- Boys Hostel
- ICT Building

Optical Fiber Layout for Security Surveillance Network – Phase 2

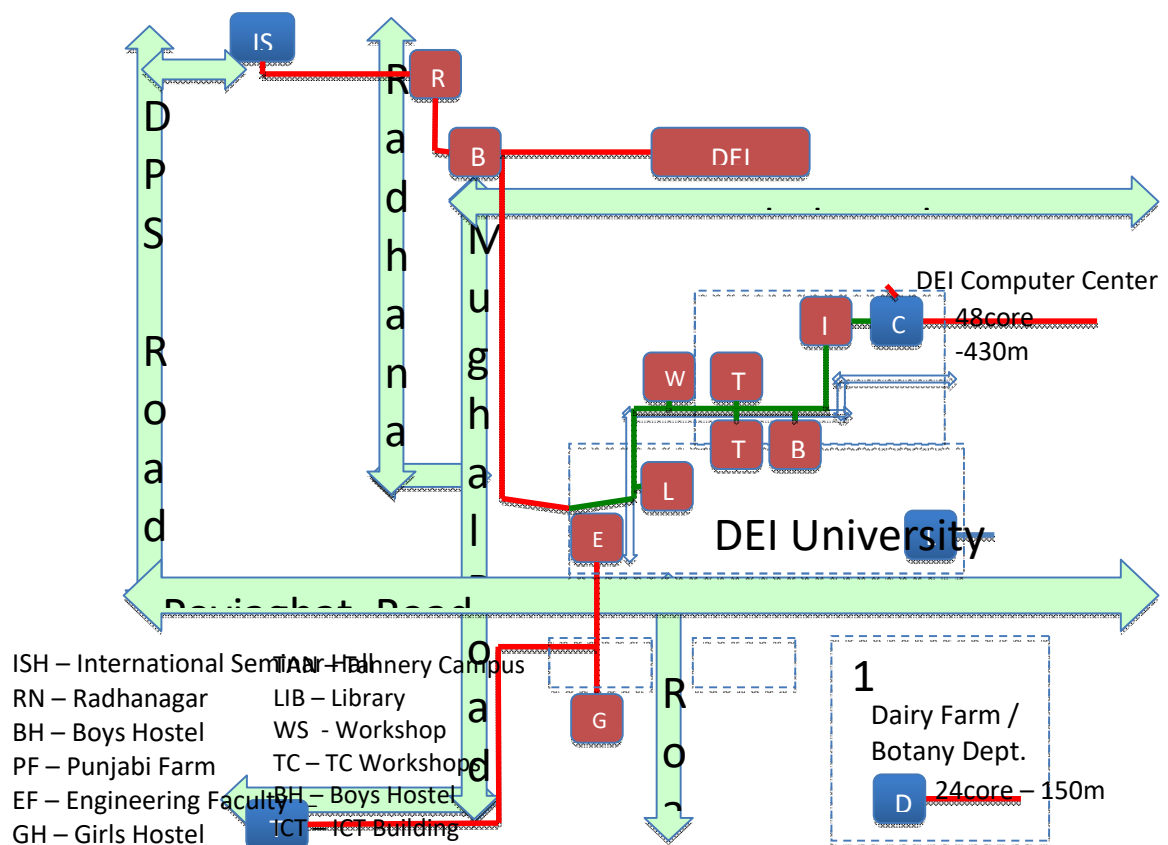

Security Surveillance inside DEI



- IP Cameras(130), IP Phones(100), Access Control at entry points
- Central and Local Monitoring Stations with 24hrs vigilance
- Assured Passive Optical Fiber Connectivity to last mile – 7km
- Local Power from Solar Plants distributed across DEI
- Long Term Storage(30days), Smart Analytics, Alarms

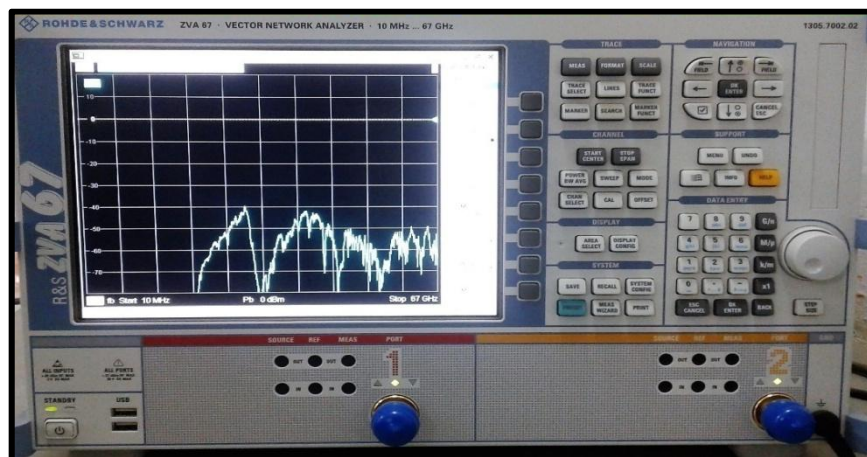

Rohde & Schwarz- ZVA 67

Vector Network Analyser

For RF & Microwave Experiments in frequency range 50MHz to 67 GHz.

Available port: 2 for microwave device characterisation involving single and two port analysis.

It also supports automatic data acquisition through VISA device drivers. Automatic data acquisition can also be done using python programming language with the help of PyVisa module. The device can also be remotely accessed in a local network.

- C. Computers & Equipments:** Worth Rs.75.30 Lacs have been purchased.
- D. Furniture:** For Rs. 11.75 Lacs has been purchased.
- E. Other Fixed Assests:** Worth Rs.28.70 lacs have been procured.
- F. Equipments:** For 176.24 Lacs have been purchased in different Faculties and Centers of the Institute.
- G. Scientfic Equipments:** Worth Rs. 118.84 lacs have been purchased for teaching and research purposes.
- H. Library Books:** Our Library is rich resources of reading material. During the year 2016-17 Books for Rs. 46.65 lacs were added to meet the needs of the students and staff.

IMPORTANT ACTIVITIES

EVENTS ORGANIZED DURING 2016-17		
S.No.	Activity	Date(s)
GENERAL ACTIVITIES		
1.	International Yoga Day	21 June 2016
2.	Celebration of 100 Years of Primary Education	1-3 July 2016
3.	World Population day	11 July 2016
4.	Environment Protection Month	19 July-31 Aug 2016
5.	Independence Day Celebrations	15 August 2016
6.	Sadbhavna Day	20 August 2016
7.	National Nutrition Week	1-7 September 2016
8.	International Literacy Week	8-14 September 2016
9.	International Ozone Day	16 September 2016
10.	International Ozone Day	16 September 2016
11.	NSS Day	24 September 2016
12.	Communal Harmony Day	2 October 2016
13.	National Unity Day	31 October 2016
14.	Vigilance Awareness Week	31 Oct -5 November 2016
15.	Celebration of Distance Learning	4-6 November 2016
16.	Annual English Drama Festival	11-13 November 2016
17.	National Integration Week	19-25 November 2016
18.	Constitution Day	26 November 2016
19.	World AIDS Day	1 December 2016
20.	National Youth Week	12-19 January 2017
21.	National Voters Day	25 January 2017
22.	Republic Day Celebrations	26 January 2017
23.	Swacchta Shapath	30 January 2017
24.	Martyrs Day	30 January 2017
25.	Founder's Day	31 January 2017
26.	Matribhasha Diwas	21 February 2017
27.	International Women's Day	8 March 2017
28.	One Day NSS Camps	Several
INNOVATIVE ACTIVITIES		
29.	Swacchta Pakhwara	4-10 December 2016
30.	Diamond Jubilee Lecture	25 December 2016
31.	Sci-High 2017	14-23 March 2017
32.	Free Medical & Rural Assistance Camps	Fortnightly
SPECIAL ACTIVITIES		
33.	NSS Seven Day Special Camp	19-25 December 2016
34.	NCC Week	20-25 March 2017
35.	Special Camp at Rajaborari, M.P	28-30 April 2017

Life Long Learning & Extension Activities (2016-17) by Department of Sociology & Political Science

Around twenty-two Short Term Certificate Courses were organised from July 2016 to June 2017 under Life Long Learning & Extension Activities. A total of 263 individuals were trained for skill enhancement & utilization of leisure in various courses- Advance Sewing & Embroidery, Textile Designing & Printing, Sewing, Tabla Vaadan, Bag making, Dholak Vaadan, Drawing, Handicraft, Machine embroidery, Mehendi Designing, Knife painting, Nib painting, Screen printing, Soft toys making, Artificial Flower making, Baking, Batik, Block printing, Fabric painting, Hand embroidery, Jute craft, Tie & Dye.

- From 1st to 25th April 2017 training in Soft toys making was organised for M.Ed. students of DEI, Faculty of Education, under lifelong learning & extension activities. During the training a group of nine students was trained in preparation of templates & drafts and making toys for different age groups & for interior decoration. Line of operation for soft toys making along with costing of the prepared item was also a part of the training in order to develop entrepreneurial skills among the participants.
- Seven students of class fifth of Bal Shiksha Kendra, Nagla Haweli successfully cleared Parishadiya Pareeksha in 2017.
- Training for women, youth and children residing in the neighbouring slums is a regular feature of Life Long Learning & Extension Activities. During 2016-17 training in Bag Making, Basic Beauty Culture, Festival Decoration, Hand Embroidery, Jute Craft, Knitting & Crochet, Machine Embroidery, Rakhi Making, Sewing, Soft toys making was conducted.
- Under DEI Entrepreneurship Programme, a total of fifty five women & girls of neighbouring community and slums are registered and are being trained in Cloth Bag Making, Embroidery, Greeting Card & Envelope Making, Handicraft, Jute Craft, Knitting, Mehendi Application, Soft Toys Making, Stitching, Textile Printing & Dyeing

A recreational camp for Junior & Senior Group children (below and above 9 yrs respectively) was organised from 22nd May to 10th June 2017 at Bal Shiksha Kendra, Nagla Haweli. A total of 45 children participated in various activities such as Drawing & Painting, Music and creative crafts. During the camp indoor games & reading room facility was also provided.

Activity	Number of participants		
	Junior Group (below 9 yrs)	Senior Group (above 9 yrs.)	Total
Creative Craft	7	12	19
Drawing & Painting	14	13	27
Indoor Games	11	10	21
Music (Vocal& Instrumental)	9	11	20
Reading Room cum Library	12	13	25



Glimpses of recreational camp at Bal Shiksha Kendra, Nagla Haweli

- World Environment Day was observed on 5th June 2017. To mark the occasion Prof. Poornima Jain delivered a talk to the women & youth of the slum on ‘Water conservation’ at Nagla Haweli centre. Drawing Competition for children of the slums at Nagla Haweli and Essay Writing Competition for DEI students & learners of short term Certificate courses was held at the Institute campus.
- Special camp organised at Rajaborari, M.P : A three day special camp was organised by a team of 14 teachers at Rajaborari in Harda district of Madhya Pradesh from 28-30 April, 2017. The objectives for the camp was imparting training to locals to initiate new activities such as ATMA, ADyNam, Textile and Educational activities.
- NCC Week was organised in the Institute from 20-25 March, 2017. Cadets participated with zeal and enthusiasm to make this event memorable and successful. To celebrate World Water Day, Poster making competition was organised based on the theme-“Save Water, Save Life”. Swaccha Bharat Abhiyan was carried out where cadets applied Zero-Waste concept and learned the new techniques being used for zero-waste management at Radhanagar, Dayalbagh. Blood Donation camp was organised in the Institute campus with the help of Samarpan Blood Bank, Agra. In the camp, 49 girl students, 49 NCC cadets, 9 staff members & 154 boys donated blood to make a total of 261 units of blood. World Tuberculosis day and E-education, E-transaction and E-literacy Day was celebrated in the NCC camp.
- **One-Day National Workshop on Higher Education for Persons with Special Needs (Rehabilitation of persons with special needs: An Affirmative approach)**

A One-Day National Workshop on the theme Higher education for persons with special needs such as physically and mentally disabled persons was organized on 31 March 2017 by Department of Sociology & Political Science. It creates an opportunity for persons with special needs for building self-confidence and to make them aware about the job opportunities and facilities provided by the government. A significant number of students belonging to SC, ST and OBC categories enthusiastically participated in the workshop. Dr. Pooja Mukul, Artificial Limbs, Jaipur, Dr. C.P Pal, Head, Dept. Of Orthopaedics, S.N Medical College, Agra, Dr. Rita Agarwal, Director, TEARS organization, Agra, Mr. Vivek Raizada, Founder, Hamare Bacche Mission, Agra were the eminent dignitaries invited in the workshop.



(anti-clockwise) Dr. Pooja Mukul delivering lecture, She is being honoured by the students attending workshop. Scenes from Cultural Programme.

Mentally challenged children of TEARS organization performed a beautiful cultural performance and disabled students shared life experiences.

• **SCI-HIGH 2017**

The Institute organized a Summer School in Science for High school students from 14 -23 March, 2017. Lectures were given on state of the art topics such as- Quantum computing, Nano-computing, Quantum Field Theory, internet & multimedia technologies, Computer Vision, solar power, Biotechnology, Green Chemistry, Opportunities & Frontiers in Life Sciences- such as Neuro-Science & Quantum Biology, VLSI technologies, Photonics, Medical science & Physiology, 3D-Printing & Automobile Engineering among others.

• **MATRIBHASHA DIWAS**

This Day was observed in the Institute on 21 Feb, 2017 with the objective to encourage students to use their own mother tongue and also the other Indian languages. The NSS volunteers took active part in various activities such as: essay writing competition, slogan writing competition and speech competition.

International Women's Day was celebrated on 8 March, 2017. On this occasion, NSS volunteers of various faculties participated in awareness programmes on social evils and emerging issues of women.

• **Diamond Jubilee Memorial Lecture**

A special lecture was delivered on the topic “Whispers from the Big-Bang and the Emerging Landscape of String Theory” in the Institute on 25 December, 2016. Prof. Sandeep P. Trivedi, Director, Prof. Shubha Tole, faculty member, Tata Institute of Fundamental Research (TIFR), Mumbai were the eminent dignitaries invited.

- **Swachhta Pakhwara** was observed from 4-10 Dec, 2016. NCC cadets took active part in ‘swachhta abhiyan’ to clean the area in and around the campus. About 80 NCC cadets participated in the Swachhta Pakhwara.
- **Vigilance Awareness Week-** The NSS Cell of the Institute organized Vigilance Awareness Week from 31 October-5 November, 2016 in which NSS volunteers participated in ‘Citizen Integrity Pledge Ceremony’ on 3 Nov, 2016.
- **Constitution Day-** 26 November, 2016 was observed as The Constitution Day, the birth anniversary of Dr. Bhim Rao Ambedkar. On this occasion, awareness programme and Speech competition on the topic ‘Contribution of Dr. B.R. Ambedkar in Indian Constitution’ was held.
- **Celebration of 100 Years of Primary Education :** In the series of ‘Celebrations of 100 years of Education in Dayalbagh’ DEI P.V Primary school and Radhasoami Saran Ashram Nagar School were fortunate to jointly organize an exhibition on the History of Primary Education in Dayalbagh from 1-3 July, 2016. Various literary and art & craft competitions were held for the students.
- **Three Day Celebrations of Distance Learning :** The Institute carried out a marvellous array of programmes celebrating the joyous occasion of completion of 100 years of Dayalbagh Education from 4-6 Nov, 2016, which comprised exhibitions, cultural programmes along with debate competition and students interaction with the industry experts. In the exhibition, a detailed history of Distance Education Programme was presented since its inception in 2004. It covered all the important landmarks such as the opening of various centres, year-wise growth of students as well as launching of programmes at the centres and establishment of workshops and laboratories.
- **Start-Up Incubators-REZ to SEZ (Rural Economic Zone to Special Economic Zone)**

In its current version, the Dayalbagh Education Policy includes and emphasizes cooperative, entrepreneurial education with multiple linkages ranging from household to international industry sector through SEZ-NDBMS (Special Economic Zone (SEZ) – Satellite Nodal Points/Nodal Districts (ND Points) – Satellite Big-Villages (B-Points)- Satellite Medium Villages (M-Points) – Satellite Small Villages (S-Points)) framework for growth and development of N/MSME’s (Nano/Micro Small and Medium Enterprises) in the country. Thus, Dayalbagh intends to move, through **Skills to Entrepreneurship, from REZ (Rural Economic Zone) to SEZ and finally to international markets, eventually evolving into IiCOuRE (India-international Centre of Urban-Rural Entrepreneurship).** DEI has designed the following three models for promoting entrepreneurship:

First Model: Supply of raw materials and marketing is done by DEI but processing is done by *adivasis*. In this model, they pay a rental charge or processing fee to DEI

Second Model: Supply of raw materials, processing and marketing – all three managed by *adivasis*.

Third Model: Supply of raw materials and processing are managed by *adivasis*, but marketing is done by DEI.

- **Jugaad Innovations at DEI**

- a) **Jugaad Innovation of e-vehicles at DEI**

Students and staff of the Technical College have designed and assembled battery-operated vehicles to aid the mobility of the old or physically challenged. These vehicles are now plying on the campus roads, and will soon be converted to a solar-operated vehicle.

- b) **Jugaad Innovation in Green Constructions at DEI**

DEI has launched innovative green constructions on the campus like Security checkposts and a Creche. These are also being expanded to off campus centres and will be extended to the community. These are low cost, environment friendly innovations with scope for further developments in the near future.

- c) **Jugaad Innovation in 3D Printing at DEI**

The revolutionary potential of Additive Manufacturing (AM) technologies hold, demands educational institutions to take up programs for its widespread adoption. At DEI, we propose “**Jugaad Innovative AM (Additive Manufacturing)**” methodology involving students to build their own 3D printers and encouraging higher adoption rate among students and educational institutions. Our methodology, a comprehensive skill set of the triumvirate of the designer, the operator and the technician is paving a suitable platform for realizing the full potential, which AM technologies hold. At Dayalbagh Educational Institute, we are providing accessible 3D Printing resources to students by giving them the opportunity to apply Jugaad methodologies to “design and build” printers using open access technology. This approach is targeted to skill the youth in STEM (Science, Technology, Engineering and Management) fields by providing them 'hands-on' experience through which they can visualize their own innovative ideas turning into reality. We aim to develop a sustainable LUMINOS (Learners, Users, Manufacturers, Innovators, Operators and Serviceman) ecosystem that not only facilitates but encourages action based learning, exploration and innovation.

- **Business Advisory Clinic** : The Department of Management operates a Business Advisory Clinic which has been offering professional advice to entrepreneurs in the local and outside community. Since 2013, it has offered advice in 3771 cases. The clients who approach the Clinic with the idea of starting a new business are advised in the preparation of a detailed Project Report and the same is vetted for the minimization of the risk. Since 2013, 15 DPRs have been completed and currently 4 cases are ongoing. During the period from 1 July 2016- 30 June 2017, 804 cases were offered professional advice.
- **Plagiarism** : A total of 109 Ph.D/ M.Phil (Thesis/ Dissertation) were checked by the Central library of the Institute during the period July 2016- June 2017
- **RTI (2016-17)**

In the period from 1 April 2016 to 31 March 2017, a total number of 43 RTI requests were received and the same were replied too.

DAYALBAGH EDUCATIONAL INSTITUTE
FACULTY OF SOAICAL SCIENCES, DEPT. OF SOCIOLOGY & POLITICAL SCIENCE
COURSE – ENVELOPE MAKING **VILLAGE – BARARAA**
Smt. Sandhya Srivastava, Smt. Richa Kudesia- Instructor

DATE – 24 TO 24 MARCH, 2017

S.No.	Name	Father's/Husband's Name	Age	Caste	Education	Occupation	Address	Remark	Signature
1.	Smt. Longshri	Sri Bhagwan Singh	70	SC	V	House Wife	Barara	Drafting	
2.	Smt. Pragdevi	Sri Jagan Singh	60	Sc	V	House Wife	Barara	Envelope	
3.	Smt. Anita	Sri Pooran Singh	35	Sc	V	House Wife	Barara	Envelope Decoration	
4.	Smt. Geeta	Sri Kalua	30	Sc	VI	House Wife	Barara	Drafting	
5.	Km. Deeksha	Sri Ashok Baghel	15	SC	VI	Study	Barara	Envelope Making	
6.	Km. Neelam	Sri Ashok Baghel	15	Sc	V	Study	Barara	Wedding Envelope	
7.	Km. Kajal	Sri Ashok Baghel	12	SC	IV	Study	Barara	Wedding Envelope	
8.	Km. Sunita	Sri Kalua	12	SC	IV	Study	Barara	Wedding Casual Envelope	
9.	Km. Preeti	Sri Jagan Singh	15	ST	VII	Study	Barara	Envelope Drafting	
10.	Smt. Kiran	Sri Balveer Singh	25	SC	VII	House Wife	Barara	Wedding Envelope Making	
11.	Smt. Renu	Sri Narendra	25	Sc	V	House Wife	Barara	Wedding Envelope Making	
12.	Km. Sapna	Sri Shyam Babu	15	Sc	VII	Study	Barara	Wedding Envelope Making	
13.	Km. Sonia	Sri Bhawar Singh	15	Sc	VI	Study	Barara	Wedding Envelope Making	
14.	Km. Rashmi	Sri Bhawar Singh	16	Sc	VII	Study	Barara	Wedding Envelope Making	
15.	Km. Priyanka	Sri Dilip Singh	18	SC	X	Study	Barara	Envelope Decoration	
16.	Km. Khushboo	Sri Gopal Singh	18	OBC	IX	Study	Barara	Envelope Decoration	
17.	Km. Geeta	Sri Nand Kishor	25	SC	X	Study	Barara	Envelope Decoration	
18.	Km. Rajkumari	Sri Ram Prakash	17	SC	IX	Study	Barara	Envelope Decoration	
19.	Km. Kajal	Sri Jawahar Singh	18	SC	XI	Study	Barara	Envelope Decoration	
20.	Km. Pushpa	Sri Tej Singh	15	SC	VII	Study	Barara	Envelope Decoration	
21.	Km. Renu	Sri Prem Singh	14	SC	VI	Study	Barara	Envelope Decoration	
22.	Km. Bhuri	Sri Rajendra Baghel	18	Sc	VII	Study	Barara	Envelope Decoration	
23.	Smt. Omwati	Sri Ram Prakash	32	SC	V	House Wife	Barara	Envelope Decoration	
24.	Km. Kavita	Sri Suresh	14	SC	V	Study	Barara	Envelope Decoration	
25.	Km. Preeti	Sri Gauri Singh	15	Sc	VIII	Study	Barara	Envelope Decoration	

Report- डी. ई. आई., द्वारा संचालित समाज विज्ञान संकाय के समाजशास्त्र एवं राजनीति शास्त्र विभाग द्वारा बरारा गाँव में दिनांक 22-24 मार्च 2016 तक लिफाफे बनाने का प्रशिक्षण दिया गया जिसके अन्तर्गत 25 प्रतिभागियों ने भाग लिया।

S.No.	Name	Father's/Husband's Name	Age	Caste	Education	Occupation	Address	Remark	Signature
1.	Km. Shivani	Sri Vanarsi Lal	19	Sc	BA	Homely	Barara	Design on Paper	
2.	Km. Anjali	Sri Vanarsi Lal	13	SC	VI	Study	Barara	Design on Paper	
3.	Km. Babita	Sri Om Prakash	13	SC	VII	Study	Barara	Design on Paper	
4.	Km. Vanana	Sri Rakesh Jha	17	SC	XI	Study	Barara	Design on Paper	
5.	Km. Vibha	Sri Dilip Kumar	13	SC	VI	Study	Barara	Design on Paper	
6.	Km. Kushboo	Sri Narendra	14	Sc	VI	Study	Barara	Making of Cone	
7.	Km. Ashmita	Sri Pavan Kumar	14	Sc	VIII	Study	Barara	Making of cone	
8.	Km. Vipasha	Sri Santosh	14	Sc	VIII	Study	Barara	Making of cone	
9.	Km. Vaishali	Sri Narendra	14	Sc	VI	Study	Barara	Design on Paper	
10.	Km. Nandini	Sri Prashuram	13	SC	VI	Study	Barara	Design on Paper	
11.	Km. Sapna	Sri Metha	13	ST	VI	Study	Barara	Design on Paper	
12.	Km. Muskan	Sri Habib	13	SC	VI	Study	Barara	Making of Cone	
13.	Km. Preeti	Sri Amar Singh	14	Sc	VII	Study	Barara	Making of cone	
14.	Km. Preeti	Sri Gauri Shankar	15	Sc	VII	Study	Barara	Rajsthani Mehandi Des. On Paper	
15.	Km. Sanjana	Sri Sailendra	14	SC	VIII	Study	Barara	Rajsthani Mehandi Des. On Paper	
16.	Km. Anjali	Sri Gauri Shankar	14	Sc	VI	Study	Barara	Aerobic Mehandi Des. On Paper	
17.	Km. Manu	Sri Shyam Veer	14	SC	VII	Study	Barara	Aerobic Mehandi Des. On Paper	
18.	Km. Aarti	Sri Jay Singh	15	Sc	X	Study	Barara	Aerobic Mehandi Des. On Paper	
19.	Km. Nikky	Sri Yogendra	14	SC	VII	Study	Barara	Aerobic Mehandi Des. On Paper	
20.	Km. Sonia	Sri syamveer	15	Sc	VIII	Study	Barara	Aerobic Mehandi Des. On Paper	
21.	Km. Kaku	Sri Syam Veer Sharma	13	SC	VII	Study	Barara	Bridal Mehandi Des. On Paer	
22.	Km. Savitri	Sri Bhagwan Das	20	Sc	VIII	Homely	Barara	Bridal Mehandi Des. On Paer	
23.	Km. Anu Priya	Sri Boby	13	Sc	VI	Study	Barara	Fill Mehandi in cone	
24.	Km. Jayanti	Sri Rajendra	15	Sc	IX	Study	Barara	Fill Mehandi in cone	
25.	Km. Richa Sikarwar	Sri. Sodan	13	SC	VI	Study	Barara	Cone Work in Paper	
26.	Km. Nisha Sikarwar	Sri Krishan Veer Singh	13	Sc	VI	Study	Barara	Cone Work in Paper	
27.	Km. Neha Sikarwar	Sri Krishan Veer Singh	13	Sc	VII	Study	Barara	Cone Work in Paper	

Report- डी. ई. आई., द्वारा संचालित समाज विज्ञान संकाय के समाजशास्त्र एवं राजनीति शास्त्र विभाग द्वारा बरारा गाँव में दिनांक 28-29 मार्च 2016 तक मेंहदी डिजाइनिंग का प्रशिक्षण दिया गया जिसके अन्तर्गत 27 प्रतिभागियों ने भाग लिया।

COURSE – SEWING

VILLAGE – BARARAA

Smt. Anita Sharma, Smt. Dayal Pyari- Instructor

DATE – 27 TO 29 MARCH, 2017

S.No.	Name	Father's/Husband's Name	Age	Caste	Education	Occupation	Address	Remark	Signature
1.	Km. Vaishali	Sri Narendra	15	OBC	VI	Study	Barara	Petticoat Making	
2.	Km. Sudha	Sri Kamla	18	OBC	XI	Study	Barara	Petticoat Making	
3.	Km. Preeti	Sri Rajendra	15	Sc	VI	Study	Barara	Petticoat Making	
4.	Km. Monu Sikarwar	Sri Shyam Sikarwar	25	SC	BA	Study	Barara	Petticoat Making	
5.	Smt. Poonam	Sri Hari Singh	20	SC	VI	House wife	Barara	Petticoat Making	
6.	Smt. Rama	Sri Mohan	25	Sc	IV	House Wife	Barara	Petticoat Making	
7.	Smt. Mamta	Sri Pappu Singh	20	SC	XI	House Wife	Barara	Petticoat Making	
8.	Smt. Urmila Devi	Sri Puran Singh	50	SC	III	House Wife	Barara	Petticoat Making	
9.	Smt. Shyam Lata	Sri Kalu	40	SC	V	House Wife	Barara	Petticoat Making	
10.	Smt. Omvati	Mr. Ram Prakash	42	SC	V	House Wife	Barara	Drafting	
11.	Km. Anjali	Sri Ajay Pal	18	SC	V	Homely	Barara	Drafting	
12.	Smt. Rekha	Sri Prem Singh	52	OBC	li	House Wife	Barara	Drafting	
13.	Smt. Priyanka	Sri Jagdish Prasad	23	OBC	VII	House wife	Barara	Drafting	
14.	Km. Shivani	Sri Vanarshi Lal	19	OBC	XI	Study	Barara	Drafting	
15.	Smt. Lalita	Sri Pratap Singh	22	OBC	BTC	Study	Barara	Drafting	
16.	Km. Vandana	Sri Rakesh	17	OBC	IX	Study	Barara	Drafting	
17.	Km. Simran	Sri Harsh	16	OBC	X	Study	Barara	Drafting	
18.	Km. Mahak Vaan	Sri Jamil Khan	16	OBC	VII	Study	Barara	Drafting	
19.	Km. Uma	Sri Shiv Prasad	15	SC	VI	Study	Barara	Drafting	
20.	Km. Sumita	Sri. Kalva	17	SC	IV	Study	Barara	Pyjama Drafting Making	
21.	Smt. Kamla	Sri Kali charan	50	Sc	II	House Wife	Barara	Pyjama Drafting Making	
22.	Km. Preeti	Sri Jagan Singh	14	ST	VII	Study	Barara	Pyjama Drafting Making	
23.	Km. Sanjana	Sri Sailendra	14	SC	VIII	Study	Barara	Pyjama Drafting Making	
24.	Km. Kiran	Sri Balveer Singh	15	SC	VII	Study	Barara	Pyjama Drafting Making	
25.	Km. Rajkumari	Sri Ram Prakash	17	SC	VII	Homely	Barara	Pyjama Drafting Making	
26.	Smt. Meera	Sri Dilip Kumar	45	Sc		House Wife	Barara	Pyjama Drafting Making	
27.	Km. Vipasa	Sri Santosh	15	OBC	VIII	Study	Barara	Pyjama Drafting Making	
28.	Km. Anju	Sri Santosh	16	OBC	VII	Study	Barara	Pyjama Drafting Making	
29.	Km. Chaina	Sri Kalu	14	OBC	VI	Study	Barara	Pyjama Drafting Making	
30.	Km. Babita	Sri Veer Pal	15	SC	VIII	Study	Barara	Pyjama Drafting Making	
31.	Km. Asmita	Sri Pavan Kumar	14	Sc	VII	Study	Barara	Pyjama Drafting Making	
32.	Km. Muskan	Sri Habib	14	Sc	VI	Study	Barara	Pyjama Drafting Making	
33.	Sri Muskan	Sri Jamil	14	SC	VI	Study	Barara	Pyjama Drafting Making	
34.	Km. Jayanti	Sri Puran Singh	15	Sc	VII	Study	Barara	Pyjama Drafting Making	
35.	Km. Kavita	Sri Suresh	15	SC	VI	Study	Barara	Pyjama Drafting Making	
36.	Km. Radha Sisoriya	Sri Gauri Sankar	17	OBC	VIII	Study	Barara	Pyjama Drafting Making	
37.	Km. Lalita	Sri Nand Kishor	18	SC	X	Study	Barara	Baby Frock	
38.	Km. Shivani	Sri Naresh Kumar	14	Sc	X	Study	Barara	Baby Frock	
39.	Km. Sonam	Sri Ganesh	14	SC	IV	Study	Barara	Baby Frock	

40.	Km. Madhvi	Sri Syam Veer	16	SC	VIII	Study	Barara	Baby Frock	
41.	Km. Rasmi	Sri Bhawan Singh	16	OBC	VI	Homely	Barara	Drafting	
42.	Km. Prarthi	Sri Amar Singh	17	SC	VII	Study	Barara	Drafting	
43.	Km. Rinki	Sri Raghuv Singh	17	SC	X	Study	Barara	Drafting	
44.	Km. Rashi	Sri Shambhu Dayal	17	Gen	X	Study	Barara	Drafting	
45.	Smt. Kamlesh	Sri Hari Singh	30	OBC	V	House Wife	Barara	Drafting	
46.	Km. Arti	Sri Jai Singh	15	OBC	VIII	Study	Barara	Drafting	
47.	Km. Shavana	Sri Jamil	14	Sc	VII	Study	Barara	Drafting	
48.	Smt. Shardha	Sri Ravindra	35	OBC	II	House Wife	Barara	Drafting	
49.	Km. Payal	Sri Dharmendra	14	OBC	VI	Study	Barara	Drafting	
50.	Smt. Kamlesh Sharma	Late Sri Sushil Sharma	44	Gen	BA	Service	Barara	Drafting	

Report- डी. ई. आई., द्वारा संचालित समाज विज्ञान संकाय के समाजशास्त्र एवं राजनीति शास्त्र विभाग द्वारा बरारा गाँव में दिनांक 28-29 मार्च 2016 तक सिलाई का प्रशिक्षण दिया गया जिसके अन्तर्गत 50 प्रतिभागियों ने भाग लिया

COURSE – SEWING

VILLAGE – BARARAA

Smt. Anita Sharma, Smt. Dayal Pyari- Instructor

DATE – 27 TO 29 MARCH, 2017

Cloth Distributed during Stitching Training at Barara

S. No.	Name of Learner	Father's/Husband's Name	Age	Cloth Distributed
1.	Smt. Lalita	Sri Pratap Singh	22	Paticot, Pajama
2.	Smt. Kamla	Sri Kali charan	50	Paticot
3.	Smt. Meera	Sri Dilip Kumar	45	Paticot
4.	Km. Radha Sisoriya	Sri Gauri Sankar	17	Frock, Pajama
5.	Smt. Urmila Devi	Sri Puran Singh	50	Petticoat
6.	Km. Lalita	Sri Nand Kishor	18	Pajama
7.	Km. Anjali	Sri Ajay Pal	18	Pajama
8.	Km. Rinki	Sri Raghuvveer Singh	17	Pajama
9.	Km. Rashi	Sri Shambhu Dayal	17	Frock
10.	Km. Monu Sikarwar	Sri Shyam Sikarwar	25	Frock, Pajama
11.	Km. Priyanka	Sri Jagdish Prasad	23	Frock, Pajama



Glimpses of Training Programme

AWARD AND RECOGNITION

Faculty of Arts

- Amit Kumar Johri, Department Drawing & Painting has been appointed as Production Manager in MHRD & UGC "SWAYAM (MOOCs) in Visual Arts" project of Rs. 1.24 crore for E-Content Development, nationally coordinated by Dept. of Drawing & Painting, Dayalbagh Educational Institute (Deemed University), Dayalbagh, Agra for 16 courses from June 2016.
- Prof. Gur Pyari Jandial was invited to present a research paper at the International workshop on 'India and Northern Europe: Identity formation, nation and knowledge transfer in the 19th and 20th centuries' at Kiel University Germany from May 14-16 2017. The title of the paper was 'Transforming Cultural Identities: A study in Punjabi diasporic experience in Britain with reference to the novels of Meera Syal and Sandhya Suri's 'I for India'.
- Prof. S.K. Chauhan, DEI, Prof. Renu Josan, Dr. Sonal Singh, Dr. Shashi Srivastava and Dr. Lowleen Malhotra acted as Resource Person in a Four-Day Short-Term Course in *Building Communication Skills in English* that was organized at the Department of English Studies, DEI from Monday 27th - Thursday 30th March, 2017.
- Prof. V. Premlata and Dr. Bani Dayal were invited for plenary talk at TSC 2017 on the Topic "Devotional Literature of Eastern Radhasoami Spirituality Philosophy: A Literary – Psychoanalytic – Consciousness Perspective.
- Prof. V. Premlata and Dr. Bani Dayal Dhir gave an invited talk 'Path to the mansion of the supreme spirit and supreme consciousness: Devotional Literature of Saints of Radhasoami Faith' during Qantas 2016 held at DEI (23-26 November, 2016)
- Dr. Bani Dayal Dhir participated in the panel discussion at East West Forum, TSC 2017, San Diego, USA.
- Dr. Bani Dayal Dhir was the Forum Coordinator at TSC 2017, San Diego, USA.
- Dr. Parul Bhatnagar acted as the Session Chair in the 'Curriculum Designing for Employability & Competency Building', an International Conference on HRD, Human Capital and Competency building, initiatives, interventions & innovations, organized by: (DDUKK) Cochin University of Science & Technology (CUSAT) on 1st Sept 2016. She also delivered an Invited Talk on the topic, "From Skills to Entrepreneurship" (A Dayalbagh Educational Institute Model) during this Conference.
- Prof Neelu Sharma was honoured by Sanskar Bharti (Agra) in Guru Poornima Samaroh on 24th July 2016.
- Dr. Seema Kashyap was appointed as a Judge and Evaluator during National Nutrition Week in September 2016 for Non-Fire Cooking Competition at Department of Food & Nutrition, Institute of Home Science, Dr. B.R. Ambedkar University, Agra.
- Dr. Madhulika Gautam received Excellence in Teaching award-201501 -05 February 2016

- Dr. Parul Bhatnagar had represented D.E.I in the UKIERI UGC Leadership development programme for Skill Development Institutions at The Lalit hotel, New Delhi from 29th Feb-5 March 2016, in which she was awarded for the most “ Enthusiastic participant of UGC and AICTE” Sponsored by UKIERI (UK-India Education and research initiative), July-August-2016
- Prof. Sanjeev Swami & Dr. Anoop Srivastava received Raj Kumar Varshney Award in Eleventh Indian Student Systems Conference organized by DEI – Dayalbagh Chapter of System Society of India on DEI values and Quality Day, Oct 19, 2016

Faculty of Commerce

- Bhawna Johri was invited as Guest Speaker in National Seminar 'Impact of Demonetization on Business: Perspective and Future Possibilities' organised by Kanoria PG Mahila Mahavidyalaya, Jaipur (Wednesday, February 7, 2017).
- Dr. Bhawna Johri was invited as Resource Person in National Seminar “Leadership and Team Building” ETI, organised by St. John’s College, Agra, 2 January, 2017 to 08th January, 2017.
- Dr. Bhawna Johri was invited to attend faculty knowledge sharing programme in "Enhancing Experimental Learning in Teaching through Innovative methods in Management" at IBS Business School on 28 August, 2016 at Hotel Seven Hills Tower, Agra.
- Dr. Anisha Satsangi was invited as Key note speaker in “2nd Two-day Multi- disciplinary National Conference on Pre-Doctoral Research, Dayalbagh Educational Institute, Dayalbagh, Agra on February 12-13, 2017
- Dr. Sanil Kumar was invited as a Resource Person in One-Day National Workshop on Course Structure & Curriculum Development for Integrated Course on Accountancy & Law, organized by Faculty of Commerce, Dayalbagh Educational Institute (Deemed University), Agra U.P. on 4th March, 2017
- Dr. Sanil Kumar received Swami Vivekananda Award 2016-17 (Best NSS PO, unit of commerce) National Social Service, Dayalbagh Educational Institute, Dayalbagh, Agra.
- Prof. Vibha Nigam acted as a resource person in NAAC sponsored national seminar on the theme “Quality enhancement in Teacher Education through academic and administrative audit” organized by Ramanujan College of Education, Palwal, Haryana, 22-23 Oct, 2016.

Faculty of Education

- Prof. K. C Vashistha has been appointed as Member: Journal of Education and Psychological Research, Rewari, ISSN No 2230-9586SNI, 2016.
- Prof. Nandita Satsangee was appointed as Chairperson at IEEE, Region 10 Humanitarian Technology Conference, 21-23 Dec. 2016.
- Prof. Nandita Satsangee was Invited at Joint Plenary Talk on 'Rural and Tribal Empowerment through Technology: DEI Initiatives' in IEEE Region 10 Humanitarian Technology Conference, 21-23 Dec. 2016.
- Prof. Savita Srivastava was invited as a ‘Guest of Honour’ in Inaugural Session, 3rd Sep. 2017, at Bharathi College of Education”, Kandari, Mandar, Ranchi, Two days’ National Seminar (from Sept. 3 to Sept. 4, 2017) on the theme of “Education in Changing Scenario”.

- Prof. Savita Srivastava was invited as a Guest Editor with rewards for Special Issues, Scientific & Academic Publishing, SAP, USA, website: <http://www.sapub.org/>, in the month of Sept. 2017.
- Prof. Savita Srivastava was awarded in the form of an Appreciation Letter for her Research Article, entitled, “A Study of Awareness of Cultural Heritage among the Teachers at University Level”, by Yrd. Doç.Dr. Aysun TUNA, İnönü Üniversitesi Güzel Sanatlar ve Tasarım Fakültesi, Peyzaj Mimarlığı Bölümü, Malatya, İnönü University, Faculty of Arts and Design, Department of Landscape, Architecture, Malatya, TURKEY, November 2016.
- Prof. Savita Srivastava was invited to deliver a talk entitled, ‘Global Consciousness for Cultivating a ‘Culture of Peace’: A Vision in Action’, at 2nd Indo-Canadian Research Colloquium UW and DEI: Education and Research in Dialogue, University of Waterloo, Canada, (through Video-conferencing with Quantum-Nano Systems Centre, DEI, Dayalbagh, India) on June 2, 2017.
- Dr. Sona Dixit delivered an invited talk on “Freedom and Rights of Women” in National Workshop on “Aadhi Aabaadi” on International Women’s Day”, organized by Institute of Home Science, Dr. B.R. Ambedkar University, Aligarh from Feb 20, 2017 to March 14, 2017.
- Prof. N.P.S. Chandel, Prof. A.K. Kulshrestha, Dr. D. Vasantha Kumari, Dr. Neha Jain and Ms. Pallavi Dubey were invited to SLVG College, Ghaziabad (UP) as resource persons in a two-day workshop on development of lesson plans based on Constructivist Approach on March 16 and 17, 2017.

Faculty of Engineering

- Prof. D.K. Chaturvedi was the Key note speaker in ‘National Conference on Communication, Network and Cyber Security on smart control using soft computing edge cutting Technology’ at Amity School of Engineering and Technology, Amity University, M.P. Gwalior on 12th April, 2017. He was invited for a guest lecture and also for judgment in inter- Departmental Project Exhibition in UDBHAV 2K17, which was held on 24th April, 2017 & organized by Department of Electrical and Electronics Engineering.
- Mr. Gurumukh Das has been elected as fellow of Indian Society of mechanical Engineering (ISME) and has been authorized to use the professional title FISME.
- Prof. D.K. chaturvedi delivered a talk on Lab View and system Control on 24th march 2017 at Anand Engineering College, Agra.
- Prof. D.K. Chaturvedi delivered an expert talk on ‘Consciousness measurement and Chakra Energy’ at Faculty of Social Science, D.E.I., Dayalbagh, Agra on the occasion of 100 years of Education in Dayalbagh on 25th Sept. 2016. He also reviewed IEEE Transactions on Power Systems manuscripts No. TPWRS-01023-2016.
- Mr. Atul Suri has been upgraded from Associate member (AMIE) to Member of Institution of Engineers (MIE), Kolkata, India with membership no. M-155767-4.
- Prof. D.K. Chaturvedi delivered a talk on ‘Consciousness and Individual Performance’ at ADRDE Lab of DRDO, Agra on 21-May 2016 on the occasion of Innovation Day 2016. He was also guest speaker in the Two-day FDP organized by the Department of EEE, G.L. Bajaj Institute of Technology and Management, Greater Noida, on 13 July 2016.

- Prof. K. Hans Raj, as the Chairman, International Society of Agile Manufacturing, felicitated Prof. Jean- Loup Chenot with “Lifetime Achievement Award” and Dr. Lionel Fourment with “fellow ISAM Award” on behalf of ISAM at the banquet of NUMIFORM 2016 at Troyes.

Faculty of Science

- Dr. Neha Pandey was conferred Young Scientist Award (2017) in Plant Science Section by the Indian Science Congress Association (ISCA)
- Saatviki Gupta, Ph.D. Scholar was selected for the DST INSPIRE Faculty Award in Feb. 2017.
- Dr. Sonal Sahai, Post Doctorate Fellow was awarded HEAM-Young Scientist Award 2016 by Indian Association of Hydrogen Energy and Advanced Materials.
- Saatviki Gupta, Ph.D. Scholar, selected for the EPSRC Global Challenges Research Fund Institutional Sponsorship Awards 2016 to visit and work at the Stephenson Institute for Renewable Energy, University of Liverpool, UK for 6 months.
- Mrs. Prem Pyari Tiwary , Ph.D. Scholar has received Best Paper award for presenting a paper entitled as “Magnetosonic Wave Evolution in the Laser Plasma Interaction” in ASAR international conference, New Delhi, 2017
- Namita Soni and Soam Prakash were conferred with James P. Joule Research Award-2016 in Nanotechnology
- Rajiv Ranjan, Department of Botany delivered invited talk on Synthetic promoters for plant Molecular Pharming in National Conference on Microbes in Extreme Environment at Department of Botany & Microbiology, H.N.B. Garhwal University, a Central University, Srinagar. He also chaired the session.
- Prof. Sahab Dass delivered an invited talk on the topic “Photocatalytic Hydrogen Production” at the National Workshop on Hydrogen Energy and Fuel Cells organized by National Institute of Solar Energy, Gurgaon during 23-24thJan, 2017.
- Prof. K.Maharaj Kumari presented a Key-note address on “Air We Breathe” in IEEE Conference at Dayalbagh Educational Institute, held on 21-23rd Dec, 2016.
- Prof. Sukhdev Roy chaired a session on Nanocomposition and another on Nano for health, and delivered an invited talk at the 4th International Conference on Nanostructured materials and Nanocomposites, at the Mahatma Gandhi University, Kottayam, Kerala from Feb. 10-12,2017.
- Dr. Shiroman Prakash has been selected as a Senior Affiliate, International Centre for Theoretical Sciences (ICTS), TIFR, Bengaluru.
- Prof. Sukhdev Roy Dept, of Physics and Computer Science, was awarded the prestigious SSI national gold medal at 40th National System Conference held at NIT Warangal.
- Dr. Dayal Pyari Srivastava Dept. of Physics and Computer Science, was awarded the prestigious SSI National gold medal at 40th National System Conference held at NIT Warangal.
- Dr. K. Soami Daya, Dept, of Physics and Computer Science, was awarded the prestigious SSI National gold medal at 40th National System Conference held at NIT Warangal.

- Prof. Sukhdev Roy was awarded Fellowship of The National Academy of Sciences. He was also awarded the Smt. Manorama Rathore Memorial Award by the Institutions for Electronics and Telecommunications Engineers, India.
- Prof. Shalini Srivastava has been admitted as a Fellow of the Royal Society of Chemistry and is entitled to use the designatory letters 'FRSC'.
- Prof. Sukhdev Roy delivered a Keynote lecture at the prestigious Convocation of the International Council of Academics of Engineering and Technological Sciences Inc. (CAETS) on, "Nano- Bio- Photonics: Integrating Technologies to meet present challenges in Energy, Mobility and Healthcare", on Oct. 14,2015.
- Prof. Sukhdev Roy received Associateship of The Abdus Salam International Centre for Theoretical Physics, Trieste, Italy (2011-2016).
- Prof. Sukhdev Roy won the Systems Society of India's National Systems Gold Medal, 2016.
- Dr. Shiroman Prakash got Early Career Research Award, DST, 2017.
- Dr. Shiroman Prakash won Associateship of Intl. Centre for Theoretical Sciences, TIFR, Bengaluru, 2017.
- Prof. Alka Prakash received the Best Paper Award at National Conference on Environmental Pollution: Consequences and Control, IIS Jaipur 2016.

Faculty of Social Sciences

- Dr. Sumita Srivastava and Ms. Kanika were given the best paper award for their paper presented on the topic 'What Affects Entrepreneurship Intentions of Young Women in India?: Current Status and the Way Forward' during the stand- up India international Conference on Entrepreneurship and Women Empowerment organized by National Institute for Entrepreneurship and small Business Development, Ministry of Skill Development and Entrepreneurship, Govt. of India Nov, 2016.
- Prof. Swami Prakash Srivastava received Bharat Ratan Dr. A.P.J. Abdul Kalam Excellence Award for outstanding individual achievements and distinguished services to the nation by Smt. Meira Kumar, Former Speaker, Lok Sabha at India International Center- New Delhi on 14th Jan, 2017.
- Prof. Sanjeev Bhatnagar delivered an invited talk as a key note speaker in National Seminar on "Foreign Direct Investment in Service sector in India" at PG Dept. of Commerce, St. Xavier's College, Ranchi in February 2017.
- Prof. Sanjeev Swami delivered an invited talk on "Interdisciplinary Research on the Interface of Supply Chain and Marketing" in workshop on "Interdisciplinary Research in Supply Chain Management & decision Sciences Applications in Business Practices" Indian Institute of Technology, Delhi, Feb 3, 2017, Dept. of Management Studies, IIT Delhi.
- Dr. Sanjay Bhusan was the invited Speaker for the theme: "Vision for Humane Education" in the 6th International Conference on Human Values in Higher Education, 10-12 Feb, 2017 at IIT Kanpur

- Prof. Poornima Jain was honoured by Panch Kalyanak Jain Samiti , Agra on 28 March, 2017 at M.D. Jain Inter College, Agra. She also delivered Lecture on “Research Methodology”, to students of Ph.D. at H.N.B. Garhwal Central University, Srinagar on 3rd April, 2017.
- Prof. Poornima Jain was invited as a Chief Guest by the Zonal Office of LIC, Agra on 1st September to inaugurate the Founder’s Day of LIC.
- Ms. Shivani Seth, of the Department of Sociology and Political Science had been selected in Northern India Internship organized by Bureau of Parliamentary Studies and Training, Parliament of India, and had successfully completed it from 03 July 2017 to 29th September 2017."

Central Library

- Dr. Mange Ram received “Achiever’s Award” for the paper entitled “Awareness with the Use of Information Resources (Information Literacy) in University Libraries of UP: AN Evaluative Study” presented in the 2nd International Conference on ‘Conjugative Management, Library Information Science, Social Science and Technology for Virtual World (ICCLIST’17)’ organized by Modern Rohini Education Society, New Delhi on 15-01-2017.
- Dr. Mange Ram received “Award of Excellence” for the paper entitled “Use of Electronic Resources in Libraries of Private Colleges of Agra District: A Evaluative Study” presented in the 2nd National Conference on ‘Library Information Science & Information Technology for Education (NCTE2016)’ organized by Modern Rohini Education Society, New Delhi on 27th August 2016.
- Ms Poonam, Library Asstt, received “Manohar Research Award” for the paper entitled “Pustkalayo Par Suchna Pradyougiki ka Prabhav evam Puskalalaya ka Swachalikaran: Ek Vichar” presented in the 2nd International Conference on ‘Conjugative Management, Library Information Science, Social Science and Technology for Virtual World (ICCLIST’17)’ organized by Modern Rohini Education Society, New Delhi on 15-01-2017.
- Dr Mange Ram, Chaired a Technical Session on National Conference on ‘LIS Profession in Digital Era Current Trends, Challenges & Future of Library and Information Science Profession in Digital Era”) on April 16th, 2017 organised by UPLA and Hindustan College of Science and Technology, Frah Mathura.
- Dr. Mange Ram delivered a Lecturer on “Shodhganga & Shodhgangotri Project: Some Issues” as a Speaker in Two Days Multi-Disciplinary National Seminar on ‘Pre-Doctoral Research (MDNSPDR-2016)’organized by Dayalbagh Educational Institute (Deemed Univ), Dayalbagh, Agra (UP) on February 06-07, 2016.

Chapter-10

SEMINARS/CONFERENCES/WORKSHOPS ORGANISED

QANSAS 2016

DEI organised International School on Quantum and Nano Computing Systems on 23-26 Nov.2016 with 24 invited speakers from top academic and research institutes including University of Waterloo, University of Edinburgh, Columbia University, New York University, University of Washington, IIT Delhi, IIT Kanpur, IIT Mumbai, IIT BHU and of course DEI, Dayalbagh.

PREM VIDYALAYA

In the series of “Celebration of Hundred Years of Education in Dayalbagh” DEI P.V. Primary School and Radhasoami Saran Ashram Nagar School were fortunate to jointly organize an exhibition on ‘History of Primary Education in Dayalbagh’ from 1-3 July, 2016 at the premises of P.V. Primary school.

Faculty of Arts

- Department of Sanskrit organized two lectures on topic ‘Vakrokti Siddhant’ on 12 Nov. 2016

Faculty of Commerce

Dept. of Applied Business of Economics

- Workshop on Commerce Education in DEI was organized on 11 September, 2016

Dept. of Accountancy & Law

- Workshop on Research Methodology on 20 March 2017

Faculty of Engineering

Dept. of Electrical Engineering

- Curriculum Development Workshop was organized by Dept. of Electrical Engg. on 24- 26 October 2016

Faculty of Science

Department of Chemistry

- Workshop on ‘Science Tools’ was organized by the Dept. of Chemistry on 31 July 2016
- Chemistry Department organized one day Seminar on 27 March 2017 on the theme “Chemical Sciences: Emerging Trends and Opportunities”.

Faculty of Social Sciences

Department of Management

- A Workshop on Role of HR in changing industrial Scenario was organized by the Dept. of Management on 15 April, 2016
- Workshop on Urban Planning & Development was organized by the Dept. of Management on 22- 23 April, 2016
- Extension & Outreach Workshop-cum Exhibition was organized by the Dept. of Management on 2- 4 July, 2016
- Workshop on “Curriculum Development in Urban Planning and Management” on July 22-23, 2016.

Department of Economics

- Workshop on Ethics & Values in Institute Education was organized by Dept. of Economics on 23- 25 September 2016

Department of Psychology

- Workshop on analysis of research SPSS-R-AMOS by the Dept. of Psychology on 22- 23 April, 2016

Department of Sociology and Political Science

- Workshop on Awareness Programme for Disable Persons on 29 March, 2017
- Organized a National Workshop on ‘ Higher Education for Persons with Special Needs’ on 31 March 2017

NEW INITIATIVES

The Institute makes continuous efforts in the direction of providing better opportunities to its students. Several new programmes are launched on a regular basis. MoUs with prestigious Universities/Institutes/Companies in India and abroad are signed to enhance teaching and research activities. Details are given below:

I. NEW COURSES

New courses approved in the session 2016-17, to be introduced at the main campus, are as under-

1. Bachelor of Fine Arts
2. Bachelor of Architecture
3. B.Voc. Water, Sanitation and Waste Management
4. M. Tech. Part-Time Programme in synchronous mode
5. Executive MBA Programme
6. Post Graduate Diploma in Human Rights and Social Work in Modular Form.
7. Post Graduate Diploma in Urban Planning and Management
8. Ph.D. Programme in Dairy Technology

New courses approved in the session 2016-17, to be introduced at various ICT/Information Centres, are as under-

1. Diploma in Engineering (Electronics)
2. Diploma in Architecture Assistantship
3. Vocational Diploma in Information Technology

II. MEMORANDUM OF UNDERSTANDING

The Institute has signed MoUs with the following prestigious Universities/Institutes/Companies in the session 2016-17:

1. Kiel University (CAU) Kiel, Germany
2. Indian Institute of Technology, New Delhi
3. Dr Y. S. Parmar University of Horticulture & Forestry, Nauni, Solan

4. Jain Irrigation Systems Limited, Jalgaon, Maharashtra
5. The Ministry of Textiles, R.K.Puram, New Delhi
6. India Yamaha Pvt. Limited

III ENTERPRENURESHIP VIRTUAL INCUBATION CENTRE (EVIC)

The EVIC aims to adopt an inter-disciplinary systemic approach, whereby initiatives will be institute-wide, without regard to departmental barriers. These initiatives will be incubated in-house with the objective of nurturing social entrepreneurs who will focus on providing low cost solutions in the following primary domains: Education (Culture, Values and Quality), Energy, Health, Water and Waste Management. The EVIC will provide all possible assistance to promote creative thinking and an entrepreneurial mindset among the students to help convert socially relevant innovative ideas into market accepted products.

Some of the activities envisaged in this direction are:

- To organize Institute-wide competitions to promote the ideation process in the following primary domains (Education, Energy, Health, Water, and Waste Management) within each existing mode of education (V/e – DEI – de):
 - Conventional Education;
 - Vocational Education; and
 - Electronic / Distance Education
- To provide mentorship to potential student entrepreneurs through industry support from alumni (AADEIs).
- To establish an Intellectual Property Rights (IPR) and Patenting Cell within the umbrella of the VIC.
- To establish a state-of-the art in-house incubation facility that will nurture and facilitate the entire ‘idea-to-startup’ activity.

e-DEI-de

Dayalbagh Educational Institute (DEI) is all set to embark on completely online delivery of Certificate Courses, Diplomas and Degree programmes through e-DEI-Distance Education (Not for profit) or e-DEI-de. Each course is divided as modules of 9-week duration. The modules are administered in an online format involving standard web-based delivery components as well as a unique aspect of online consulting and discussion forums through audio and video conferencing. A student will enrol for a module or a course and after completing the requirements for the module or the course will be awarded a module or course completion certificate.

The subjects for Certificate programmes will range from common soft skills to highly demanded management courses to contemporary nano technology and esoteric consciousness studies. Gradually, the programmes will include Diplomas and Degrees in Management, Computer Science

and Engineering. For these programmes, Personal Contact Modules will be organized for the students of the professional programmes so that a unique experience is created.

REVITALIZING SCIENCE EDUCATION

DEI considers science education as an essential component of all round progress. It has taken up some creative initiative on campus and in remote areas of arousing the interest of students especially those who come from underprivileged backgrounds to ignite their interest and curiosity in Science. These include:

1. **Si-Hi:** Summer School in Science for High school students has been started on a regular basis.
2. **Virtual Labs** under the Ministry of Human Resource Development have expanded the access to laboratory experimentation in remote areas.
3. **Frugal Science Experiments** in collaboration with Stanford University, USA, have infused a spirit of enquiry and creativity among school going students.
4. **Hole in the Wall : A Computer Literacy programme for underprivileged children** is organised regularly by the DEI faculty as an extension of the Medical camps, mentioned in the following sub-section.

Hole in the Wall

- “Hole in the Wall Experiment” is also conducted, with the objective of promoting computer literacy among tribal children.
- Village children are given free access to use Laptops/ Computers and are allowed to learn on their own with minimal guidance.
- The program has become highly popular with village children who eagerly look forward to these sessions.



Chapter-12

MISCELLANEOUS

Annual English Drama Festival-2016

Intending to inculcate theatrical skills and foster creativity amongst the students, the Annual English Drama Festival, which has become a much-awaited event amongst the theatre lovers of educational institutions in Agra district, was organized by the Department of English Studies, DEI from 11 to 13 November, 2016. The festival was divided into two categories, one for schools and the other for Colleges/Faculties, in which twelve teams presented an assortment of different genres of dramatic works and competed for prizes. Ranging from Roman Tragedy *Medea* to the abridged version of Shakespeare's *The Taming of the Shrew*, from iconic plays like, George Bernard Shaw's *Pygmalion* and Marlowe's *Dr. Faustus* to Indian English dramatist Dattani's influential plays *Dance Like a Man* and *Seven Steps Around the Fire*, the audience at DEI's Convocation Hall were offered theatrical treat. Each drama was presented with the greatest of talent, and made it a tough competition for the others. Amongst the schools that participated were, DEI Prem Vidyalaya, St. Clare's Sr. Sec. School, Agra, G.D. Goenka Public School, Agra and Sumeet Rahul Memorial School, Agra. Amongst the colleges that took part were, St. John's College, Agra, Hindustan College of Engineering, Agra and six Faculties of DEI. The Jury this year comprised eminent personalities like, Mrs. Vandana Ghosh, Principal, Shri Ram Centennial Sr. Sec. School, Agra; Mrs. Namita Sood, Vice Principal, Delhi Public School, Agra and Mrs. Snehmala Sehgal, Managing Director, CADD Centre, Agra. The Chief Guest, Shri Prabhash Kumar, Divisional Railway Manager, Agra, gave away the prizes to the enthusiastic participants. This year, the Best Production Prize was taken away by DEI Prem Vidyalaya and Faculty of Science, DEI at the School and College levels respectively while Sumeet Rahul Memorial School and Hindustan College of Science and Technology bagged the Best Director Award at their respective levels. Prof. J.K. Verma, Head, Department of English Studies, DEI, Prof. P.K. Kalra along with the Registrar, DEI – Prof. Anand Mohan gave their valuable time by being present on all three days. The efforts of the organizers bore fruit when the Festival was blessed by the August Presence of Most Revered Prof. P.S. Satsangi Sahab, Chairman, Advisory Committee on Education, Dayalbagh Educational Institutes and Most Respected Rani Sahiba, along with many dignitaries of Dayalbagh and Agra. The massive turn out of students, staff, guests and others on all the three days made the event a huge success.

DEI students Display Vivacity in Youth Parliament

In the group level competition of Model Youth Parliament conducted by the Ministry of Parliament Affairs, the students of DEI presented a perfect pattern of working of the Lok Sabha on 14 September, 2016. The Hall at the International Seminar Complex of the Institute was looking like a striking model of the Chamber of the Indian Parliament, with Speaker seated at the centre of the House, members of the Opposition seated on the left of the rostrum and the seats for the Government benches on the right of the rostrum. There was also a gallery for the Press and the Foreign Delegates.

The practices and proceedings, which are normally taken up in the Lok Sabha Session, were immaculately represented by the student representatives of DEI, who seemed to be well acquainted with the current social and civil issues. During the question hour, the representatives of the Opposition (Kanishka Kohli, Saloni and Mahima Satsangi) raised the issues related to internal security, sports and water crisis and took the Government to task. Anubha Singh, Yogi Chaudhary and Abhinav Dayal Saxena, who were representing the ruling party, showed a lot of wit and dynamism in giving balanced answers to these questions/charges. Ambika Reddy, as the Human Resource Development Minister, presented a bill related to 'Common School System'. Later, in the 'Calling Attention Motion', a good debate took place between the members of the Government and the Opposition.

Addressing the issues and charges related to reservation and education, Udit Tiwari, in the role of the Prime Minister, appealed to all the members of the house to work in co-operation and solve the difficulties keeping public interest in view. The session was presided over by Rhimanshi Mukund who was present as the Speaker of the House.

The Jury for judging the performance comprised eminent personalities like, Sh. Babulal, Hon. Member of Parliament, Prof. Kushal Sen from Delhi University and Prof. Dinesh Arora from D.A.V. College, Jalandhar. All three members lauded the organization and presentation of model Parliament by DEI and expressed their appreciation of the way the students had displayed their cognizance about the current state of affairs that the country is facing. The following six students were chosen by the Jury for the award of best performance:

- Rhimanshi Mukund – Speaker
- Udit Tiwari – Prime Minister
- Ambika Reddy – Human Resource Development Minister
- Nivedita Vashishtha – Member, Opposition
- Anushka Srivastava – Member, Opposition
- Antra Prakash – Member, Opposition

Three-day celebrations of distance learning segment of DEI

As a part of the series of three-day celebrations of various segments of DEI, the Institute's distance learning segment organised a number of programmes celebrating the joyous occasion of completion of 100 years of education in Dayalbagh. The celebrations, which were held from 4 to 6 November, 2016, comprised exhibition, cultural programme along with debate competition and students' interaction with the industry experts.

In the Exhibition, a detailed history of Distance Education Programme was presented, starting from its inception in 2004. It covered all the important landmarks such as the opening of various centres, year-wise growth of students as well as launching of programmes at the centres and establishment of workshops and laboratories.

The second element of the celebrations, the Cultural Programme along with Debate Competition & Students' interaction with the industry experts, was spread over two days viz. on 4 and 5 November, 2016 from 2 pm to 5 pm at the Hall of Technical College.

The topic of the debate was: ‘ADVANCES IN TECHNOLOGY ARE SURE TO BRING ABOUT THE DOOMSDAY’. Students from Ellora, Agra City and Adanbagh Centres participated in the debate. The following eleven Centres participated in Cultural Programme on 4 and 5 November: Adanbagh, Agra City, Ellora, Jaipur, Gurgaon, Murar, Karolbagh, Jamshedpur, Noida, Soami Nagar and Visakhapatnam (DN). The Cultural Programmes performed by the Centres included regional songs, qawwalis, nukkad-natak, skits, English play, Bhakti sangeet & Bhangra dance. A ‘Sooli Dance’ was directed by the Theology Team, which was performed by the children of School of Art and Culture, Dayalbagh. The title was “Chaap Tilak Sab Chheeni”-“When I saw my Love, I lost my identity’.

The interaction with the industry experts was organized on the last day. The panel consisted of ten experts from the industry. Students from different Faculties and Institutions of DEI attended the Panel Discussion in addition to the Distance Education students. The complete Cultural Programme along with the Panel Discussion was transmitted to all the 90 Information Centres on both the days.

Enthusiastic celebration of 100 years of education by Women’s Polytechnic

DEI Women’s Polytechnic celebrated 100 years of Education in Dayalbagh from 21 to 23 October, 2016. With an aura of majestic Mughal theme decoration, the walls, garden area and boards of the premises were adorned with Mughal designs. An exhibition, ‘DarpanEItihaas’, portraying the progress and historical development of WPT was also put up on this occasion. The Garment Technology branch organized a Zardozi Workshop for students. A Colour Workshop was also conducted jointly by Pidilite and Interior and Textile branch in which students were taught about modern techniques of textile designing and printing. Besides these, multihued models were demonstrated which comprised articles made from e-waste materials, models on Landscaping and different Interior Designs, Architectural Building models and Geodesic model. Along with this, some fun games were also organized for the visitors. Students’ ingenuity was revealed in creations of various styles of blouses, evening gowns and ramp show and there was an active participation in Debate entitled ‘Competence and knowledge of teachers is the essence of the progress of any Institute’. Mouth watering pickles, colourful dupattas, dress materials, lamps, etc. which were displayed in the stalls, were also a great attraction.

Some interactive talks were also organized. Mr. Sarfraz Hasan, CEO, LED MEC London, delivered his interactive talk-cum-presentation on Entrepreneurship on 21 October and Dr. Darlie Koshy, DG, ATDC, spoke on Skills on 22 October. An Alumni meet was also held. The Cultural Programme added colour to the festivities by a Qawwali, Musical Drama ‘Navras Vedana’ and ‘Lok Jhalak’.

QANSAS 2016

International School on Quantum and Nano Computing Systems (QANSAS 2016) was organized from November 23-26, 2016 with 24 invited speakers from top academic and research institutes including University of Waterloo, University of Edinburgh, Columbia University, New York University, University of Washington, IIT Delhi, IIT Kanpur, IIT Mumbai, IIT-BHU and, of course, DEI, Dayalbagh. A special forum on ‘Integrating Eastern and Western Perspectives of Consciousness’ was organized on November 23 with the Vision Talk delivered by Most Revered

Prof. P.S. Satsangi Sahab, Chairman, Advisory Committee on Education, Dayalbagh Educational Institutions and Plenary Talk by Prof. Rafael Yuste, Director, Neuro Technology Center, Columbia University. The Inaugural Talk was delivered on November 24 by Prof. Craig Hogan, Director, Fermilab Center for Particle Astrophysics, University of Chicago. Workshop on Contextuality was conducted on November 25 by Dr. Joel Wallman, Institute for Quantum Computing, University of Waterloo. The Valedictory Talk on November 26 was delivered by Prof. Ian Underwood, Head, Institute for Integrated Micro and Nano Systems, University of Edinburgh. There were two lively panel discussions moderated by Mr. Prem Prashant.

Annual prize distribution function of DEI Prem Vidyalaya

The Annual Prize Distribution function of DEI Prern Vidyalaya, Girls' Intermediate College was held on 21 Nov 2016. It was graced by the benign presence of most Revered Prof. P.S. Satsangi Sahab, Chairman, Advisory Committee on Education, Dayalbagh Educational Institutions and most Respected Rani Sahiba. The Programme began with the Prayer, 'Tere charnon mein'. The Principal of the College Dr. Mala Bal welcomed the guests and presented a brief report of the progress of the College. Thereafter, a shabd recital "Dhanya sudeshjahan tum baste, bhumi pavitra jahan pug dharte" was presented. Prof. P.K. Kalra, Director, DEI presented prizes to the students who excelled in academic and cultural activities. In his brief address, he praised the College for its progress and also for the successful implementation of new evaluation scheme such as DHA programme. Vice Principal, Ms. Jayati Mathur, gave vote of thanks. The function concluded with the melodious recitation of the College song.

Centenary of Education in Dayalbagh Celebrated at Faculty of Engineering

In tune with the ongoing series of events marking the celebration of glorious hundred years of education at Dayalbagh, the Engineering Faculty of DEI organized threeday celebration, which was held from 2-4 September, 2016. The budding engineers of the Institute, under the able supervision of their teachers, employed their best efforts to showcase their knowledge, creativity, talent, dynamism and vision, reflecting their all round development attained through DEI education.

An Exhibition on the History of Engineering Education in Dayalbagh was impressively displayed on all three days that not only applauded the glorious past in the form of erstwhile Engineering College, but also the bright present of the Faculty. The display of working models & charts by students mirrored their interests and awareness in their related fields.

The three-day Workshop on Robotics garnered a lot of attention and interest of students, which could be seen in their participation in large numbers. An interesting cultural extravaganza was also put up on all three days that brought out the students' talent in singing, dancing, musical show and dramatics. The students also got a chance to display their sporty side through events like Tug-of-War and Volley ball matches. A unique element of the celebrations was a Student Conference based on the model of United Nations Conference, where students in the role of representatives of different member countries expressed their concern over serious issues concerning violation of Human Rights around the world.

Some other highlights of the celebrations were, interaction with alumni, special talks by eminent personalities like, Er. S.V.S. Rathore, MD, DVVNL, Agra; Air Cdr. Amit Tyagi, Prof Karmeshu, Prof. Emeritus, JNU, Delhi and Er. K.L. Verma (CEO-Sunflame) and some other reputed

personalities. Felicitation of the retired teachers was also one of the highlights of the occasion. Above all, the celebration received a great boost when the Faculty was blessed by the August Presence of Most Revered Prof. P.S. Satsangi Sahab, Chairman, Advisory Committee on Education, Dayalbagh Educational Institutions.

DEI Diamond Jubilee Lecture

The DEI Diamond Jubilee Lecture on ‘Whispers from the Big Bang and the emerging landscape of String Theory’ was delivered by Prof. Sandeep P. Trivedi, FNA, FASc., Director, Tata Institute of Fundamental Research, Mumbai at the Convocation Hall, Dayalbagh on 24th December 2016 at 2:30pm.

Celebrations Galore at the Faculty of Social Sciences

100 years of education in Dayalbagh was celebrated with pomp and enthusiasm in the Faculty of Social Sciences from 23 -25 September 2016. On these three days there was an exhibition in the faculty along with the display of models and posters on Entrepreneurship & Consciousness. For the amusement of the students a Fun-Zone was created with games based on entrepreneurship. Some psychometric tests were also conducted to acquaint the gathering with the dimensions of the field of Psychology. To promote the study and experiences of consciousness, there were some ‘Chakra Healing Sessions’ organized from 10:30 am to 4:00 pm on these three days.

Amongst the events conducted on 23 September were the workshop on dramatics, competition on ‘art from waste’ and poster competition on consciousness. Students of the Faculty of Social Sciences presented a Nukkad Natak on this day, which was followed by an impressive Panel Discussion on “Water Management”.

On 24 September, a session on Yoga was conducted while judgment of posters and models was also made. There were some invited talks for ‘Entrepreneurial Mindset & Start-up Scenario in India’. The same day the Chairman Advisory Committee on Education, Most Revered Prof. P.S. Satsangi Sahab, Graced the occasion by His presence and attended the Invited talks of Prof. Pami Dua, Director of Delhi School of Economics and Dr. Anita Sharma. It was followed by a colourful cultural programme.

On 25 September, the alumni of DEI were invited for interaction which was followed by the NGT workshop on Entrepreneurial Education. Towards the end of this last day of celebrations, the enthusiastic & eager students were acknowledged for their efforts at the Prize Distribution function.

DEI Special Lecture

The DEI Special Lecture on ‘Towards a blueprint for building the brain’ was delivered by Prof. Subha Tole, Tata Institute of Fundamental Research, Mumbai at the Convocation Hall, Dayalbagh on 24th December 2016 at 3:30pm.

Inauguration of DEI-TVS Community College in DEI Campus

The Dayalbagh Educational Institute and TVS Motor Co. Ltd signed an M_oU on 22 September 2016 to start the DEI-TVS Community College, in the DEI campus. Here, two programmes, one for Sales training and another for Service training will be offered.

Prof. Prem Kumar Kalra, Director, DEI signed the MoU on behalf of DEI and Dr. V. Kovaichelvan, Senior Vice President-HR signed it on behalf of TVSM. A modern Training Workshop, along with two classrooms, was also inaugurated. The Workshop will cater to the training needs of the enrolled students. The Workshop is equipped with two lifts, parts cleaner, battery charger, spark plug cleaner & tester, nitrogen tyre filling in addition to general & special tools and other equipment, cutsection models & engines, and a variety of scooters and motorcycles for student practice. Two trainers underwent basic training at the company's plant at Hosur. They also underwent special training at the company's Training centers for sales and service respectively.

The programme was well attended by around 30 representatives of TVSM dealers of UP & Delhi and some company officials. The dealers were happy to see the facilities in the Training Workshop and have high hopes of getting trained manpower from DEI. Dr. V. Kovaichelven stressed that trained manpower is the need of the hour. Shri Niraj Kumar, GM Service, TVSM said that both TVSM and DEI have a 100 year history and their coming together will benefit the underprivileged youth of the society. Shri. U.B. Pandey, Associate Vice President Sales and Regional Business, Head Worth, spoke on improving customer experience. Prof. Kalra, Director, DEI floated an idea that DEI and TVSM could take such social responsibility initiatives in other places also where DEI has its presence, for the benefit of the backward and underprivileged sections of the society. Prof. Anand Mohan, Registrar, DEI traced the genesis of today's occasion and said that in Dayalbagh and DEI we move forward with evolution rather than revolution. He further said that such progress is always stable and sustainable. Dr B.B. Rao, Principal, D.E.I Technical College assured everyone that the goal of setting up the facility will be met well by trained mechanics to cater to the needs of the two-wheeler industry.

The two programmes envisage 1 module of classroom training, comprising both theory and practice, and thereafter 3 modules of on-the-job training at the company's dealerships in the hometown of the student. After successful completion of the training, the student will be offered employment in the company's dealership and the dealer will reimburse his course fees. The student will also be given two sets of college uniform free of charge.

GOVERNING BODY - LIST OF MEMBERS**TERM: 2014-2017 Total Members: 14 Quorum: Eight (As on 1-JUL-2016)**

<u>Status of Nomination</u>		<u>Name of the member</u>
(a)	1. Director (Ex-officio)	Professor P.K. Kalra Director Dayalbagh Educational Institute Dayalbagh, Agra-282 005
(b)	2. Treasurer (Ex-officio)	Smt. Sneha Bijlani Treasurer Dayalbagh Educational Institute Dayalbagh, Agra-282 005
(c)	3. Two Deans from amongst the Deans of the Faculties of the Institute by rotation in alphabetical order of the names of the Faculties. (Ex-officio) (Term-One year: 2015-16: Commerce & Education	Prof. S.K. Gaur Dean, Faculty of Engineering Dayalbagh Educational Institute Dayalbagh, Agra-282 005
	4. -do-	Prof. Ravinder Kumar Dean, Faculty of Science Dayalbagh Educational Institute Dayalbagh, Agra-282 005
(d)	5. One nominee of the Ministry of Education, Govt. of India. (From Sep., 2013) Mob.: 9899236578 Email: nath.satya@gmail.com kishore_prum@gmail.com	Ms. Neelam Nath F-1104, Park View City-II Sohna Road, GURGAON
(e)	One nominee of Chairman, UGC	<i>Not Needed as per UGC Regulations, 2010</i>
(f)	6. Director, Higher Education, Uttar Pradesh (Ex-officio) 0532-2421213 Phone : 9415295755	Shri R.P. Singh Director Higher Education, U.P. Directorate of Higher Education Post Bag No.005 ALLAHABAD-211 001
(g)	7. One nominee of the Academic Council of the Institute from among its members as specified in Rule 13(c) and (d).(Term: 2015- 18) (w.e.f. 2.12.2016)- VRS(20.5.17)	Prof. Ravi Sidhu Department of Home Science Faculty of Arts

- | | | | |
|-----|-----|---|---|
| (h) | 8. | One nominee of the Radhasoami Satsang Sabha, Dayalbagh, Agra | Dr. Vijai Kumar
3/218, Prem Nagar
Dayalbagh, Agra-282 005 |
| (i) | 9. | One nominee of the Managing Committee of the Radhasoami Educational Institute of Agra, Dayalbagh, Agra | Shri Prem Prashant (IAS Retd.)
3/21, Prem Nagar
Dayalbagh, Agra-282 005 |
| (j) | 10. | One representative each of Industry and Agriculture of Dayalbagh, to be nominated by the President of the Institute.
Phone: Res. (011) 26148542
Off. (011) 26149648
Mob. 09810029790
rksinha@vsnl.com | Shri Ravi Kumar Sinha
B-2/6, (Ground Floor)
Vasant Vihar
NEW DELHI-110 057 |
| | 11. | -do- | Prof. S.S. Bhojwani
3/43, Prem Nagar
Dayalbagh, Agra-282 005 |
| (k) | 12. | Three persons, not being members or employees of the Institute to be nominated by the President of the Institute from amongst eminent educationists and technologists. | Professor R. N. Mehrotra
3/189, Prem Nagar
Dayalbagh, Agra-282 005 |
| | 13. | -do- | Professor V.B. Gupta
3/173, Prem Nagar
Dayalbagh, Agra-282 005 |
| | 14. | -do- | Professor P. Sriramamurti
4/112, Vidyut Nagar
Dayalbagh, Agra-282 005 |

-----X-----

RULE: 8
PRIMARY BODY - LIST OF MEMBERS

TERM: 2014-2017 Total Members: 24+1 Quorum: Eight (As on 20-3-2017)

Chairman: Shri Prem Kumar

<u>Status of Nomination</u>	<u>Name of the Member</u>
(a) 1. Six members to be nominated by the members of the General Body of the Dayalbagh Educational Institute	VACANT DUE TO SAD DEMISE OF SHRI SARAN PRASAD (Prof. Satya Prakash has been nominated w.e.f. 1.7.17)
2. -do-	Prof. R.N. Mehrotra 3/189, Prem Nagar Dayalbagh, Agra-282 005
3. -do-	Prof. P. Sriramamurti 4/112, Vidyut Nagar Dayalbagh, Agra-282 005
4. -do-	Shri Prem Prashant 3/21, Prem Nagar Dayalbagh, Agra-282 005
5. -do-	Prof. S.S. Bhojwani 3/43, Prem Nagar Dayalbagh, Agra-282005
6. -do-	Shri Gurmeet Singh 3/157, Prem Nagar Dayalbagh, Agra-282 005
(b) 7. One nominee each of the three educational societies, viz. The DEI Women's Training College Society (WTC), the DEI Engineering College Society (EC) and the Managing Committee of the Radhasoami Educational Institute of Agra (MCREI).(WTC) Email: rajivsinha@gmail.com	Shri Rajiv Sinha Senior Advisor DCM Shriram Ltd. A-14/14 Vasant Vihar NEW DELHI-110 057
8. (EC) -do-	Prof. N. Satyanarayana Murthy 3/13, Prem Nagar Dayalbagh, Agra-282005
9. (MCREI) -do-	Shri Prem Kumar (Retd. IAS) 3/36, Prem Nagar Dayalbagh, Agra-282 005

- | | | | |
|-----|-----|--|---|
| (c) | 10. | One nominee of the Dayalbagh Medical Relief Society | Dr. Ashok Kumar Nigam
14, Radha Nagar
Dayalbagh, Agra-282 005 |
| (d) | 11. | One trustee of the Dayalbagh Education Turst, to be nominated by the trustees of the Trust | Prof. Satya Prakash
3/201, Prem Nagar
Dayalbagh, Agra-282005 |
| (e) | 12. | One nominee of the Ministry of Education, Government of India

Phone: 9560988099 | Ms. Rina Sonowal Kouli
The Director
Dept. of Higher Education,
MHRD,
Shahstri Bhawan
NEW DELHI-110 115 |
| (f) | 13. | Secretary Education, Uttar Pradesh
(Ex-officio) | The Secretary
Higher Education (Section-4)
U. P. Government Sachivalaya
LUCKNOW |
| (g) | 14. | One nominee of the All India Council for Technical Education
Tel: 011-2613149
Email:
mppoonia11@gmail.com | Dr. M. P. Poonia
Vice-Chairman, AICTE
Nelson Mandela Marg
Vasant Kunj
NEW DELHI-110067 |
| (h) | 15. | Deans of Faculties
(Ex-officio)

(W.E.F. 1.7.2014 to 30.6.2017) | Prof. Ragini Roy
Dean, Faculty of Arts
Dayalbagh Educational Institute
Dayalbagh, Agra-282 005 |
| | 16. | -do-
(1-7-2016 to 30-6-2019) | |
| | 17. | Deans of Faculties
(Ex-officio)

(w.e.f. 27.7.2016) | Professor K.C. Vashishtha
Dean, Faculty of Education
Dayalbagh Educational Institute
Dayalbagh, Agra-282 005 |
| | 18. | -do-

(w.e.f. 1.6.2016 to 31.5.2019) | Prof. S.K. Gaur
Dean, Faculty of Engineering
Dayalbagh Educational Institute
Dayalbagh, Agra-282 005 |
| | 19. | -do-

(w.e.f. 15.11.14 to 14.11.17) | Professor Ravinder Kumar
Dean, Faculty of Science
Dayalbagh Educational Institute
Dayalbagh, Agra-282 005 |

Rule: 16

FINANCE COMMITTEE - LIST OF MEMBERS

TERM: 2014-2017 Total Members: 6 Quorum: Three (As on 1-JUL-2016)

	<u>Status of Nomination</u>	<u>Name of the Member</u>
(a)	1. Director (Ex-officio)	Professor P.K. Kalra Director Dayalbagh Educational Institute Dayalbagh, Agra-282 005
(b)	2. Treasurer (Ex-officio) Phone: 9897468691	Smt. Sneh Bijlani Treasurer Dayalbagh Educational Institute Dayalbagh, Agra-282 005
(c)	3. One nominee of the Department of Finance, U.P. Government. Phone: 2420543 (O)	Shri R.K. Singh Additional Director (Treasuries) Agra Mandal Opp. D.M. Office Near Imperial Hotel, Agra
(d)	4. Two nominees of the Governing Body, one of which shall be a Dean (GBMR-10 dt. 3-5-2014) (Term upto 26.7.2016)	Prof. (Smt.) Vibha Nigam Faculty of Education Dayalbagh Educational Institute Dayalbagh, Agra-282 005
	5. -do-	Shri A.P. Sinha 3/169, Prem Nagar Dayalbagh, Agra-282 005
(e)	6. One Nominee of the MHRD Ph.: 011-26475905/26211211 (Mob.) 9811680614 (From Sep,2013) Email: vermamanan06@gmail.com	Shri Madan Verma 1209, Hemkunt Chambers 89, Nehru Place NEW DELHI- 110019

RULE : 19

LIST OF MEMBERS

Managing Council for the Non-University General Educational Institutions

TERM: 2016-2019 Total Members: 19 Quorum: Six (As on 1-7-2016)

	<u>Status of Nomination</u>	<u>Name of the Member</u>
(a)	1. Director (Ex-officio)	Professor P.K. Kalra Director Dayalbagh Educational Institute Dayalbagh, Agra-282 005
(b)	2. Treasurer (Ex-officio)	Smt Sneh Bijlani Treasurer Dayalbagh Educational Institute Dayalbagh, Agra-282 005
(c)	3. Principals of Non-Univ. General Educational Institutions(NUGEI) (Ex-officio)	Dr.(Ms) Mala Bal Principal DEI P.V. Girls Intermediate College Dayalbagh, Agra-282 005
	4. -do-	Dr. R.B. Dixit Principal REI Intermediate College Dayalbagh, Agra-282005
	5. -do-	Sh. D.S. Kapoor Principal, Radhasoami Adivasi Higher Secondary School, C/o Manager Rajaborari Estate TIMARNI (Dist. HARDA (MP)-461228
	6. -do- (R) 9871000140 (O) 41748661	Ms. Anita Kheterpal Principal Soami Nagar Pre-Primary School C-33,Second Floor, Soami Nagar (North) New Delhi-110017
	7. -do- Mob. 9810282419 email: arti.snms@gmail.com	Mrs. Arti Prasad Principal Soami Nagar Model School Soami Nagar (North) New Delhi-110017

- | | | | |
|-----|-----|---|--|
| | 8. | Principals of Non-Univ. General Educational Institutions (NUGEI) (Ex-Officio)

7830507157 (Mob.)
9286542683 (Mob.)
9997137127 (Mob.)(19.3.2016)
Email:
tiwariusha1959@gmail.com | Ms. Usha Tiwari
Principal
Roorkee Model School
S-3, Handloom Industry,
Dayalbagh Colony,
Ganeshpur (Near Railway Station
ROORKEE-247 667 |
| (d) | 9. | One teacher from each of the NUGEI by rotation in order of seniority (Term-One year) (2016-2017) | Ms. Sita Rani
Assistant Teacher
DEI P.V. Girls Intermediate College
Dayalbagh, Agra-282 005 |
| | 10 | -do- | Shri Sailesh Choudhary
Lecturer
REI Intermediate College
Dayalbagh, Agra-282 005 |
| | 11 | Teacher representative of Soami Nagar Model School (2016-17) | Ms. Surbhay Kumar
Teacher
Soami Nagar Model School
Soami Nagar (North)
NEW DELHI-110017 |
| | 12. | -do- | Ms. Swarup Rani Vinaik
Teacher,Radhasoami Adivasi
Higher Secondary School,
C/o Manager
Rajaborari Estate
TIMARNI, Dist Harda (MP)461228 |
| (e) | 13. | Two nominees of the Governing Body from amongst its members (GBR-14 dt.5.3.2016) | Sri Prem Prashant
3/21, Prem Nagar
Dayalbagh, Agra-282005 |
| | 14. | -do- | Prof. V.B. Gupta
3/173, Prem Nagar
Dayalbagh, AGRA-282 005 |
| (f) | 15. | Director, Secondary Education, Uttar Pradesh (Ex-officio) | The Director
Dept. of Secondary Education
Directorate of Secondary Education
U.P. Government
LUCKNOW |

- (g) 16. One nominee of Ministry of Education, Government of India.
Ph.: (O) 011-23381894
Fax: 011-23070173
(Re-nomination for three years w.e.f. March, 2014)
Mob. 9560988099
Upto March 2017
- Ms.Reena Sonowal Kouli
Director
Dept. of Higher Education,
MHRD,
Shahstri Bhawan
NEW DELHI-110 115
- (h) 17. One nominee of the Managing Committee of the REI, Dayalbagh, Agra
- Prof. S.S. Bhojwani
3/43, Prem Nagar
Dayalbagh, Agra-282 005
- (i) 18. One nominee of the DEI Prem Vidyalaya Society, Dayalbagh, Agra.
- NIL
- (j) 19. One nominee of the DEI Higher Secondary School Society, Dayalbagh, Agra.
- NIL
(Society Merged with MCREI)
- (k) 20. Two persons not being members or employees of the Institute including non-university educational institutions to be nominated by the President of the Institute from amongst eminent educationists and technologists.
- Professor Asha Sinha
(Ex-Professor of Home Science)
3/52, Prem Nagar,
Dayalbagh, Agra-282005
21. -do-
- Shri Vidhu Kashyap
The Manager
Rajaborari Estate
Timarni, Distt. Harda-461 228
(M.P.)

RULE : 18

LIST OF MEMBERS

Managing Council for the Non-University Technical Educational Institutions

TERM: 2016-2019 Total Members: 11 Quorum: Six (As on 1-JUL-2016)

	<u>Status of Nomination</u>	<u>Name of Member</u>
(a)	1. Director (Ex-officio)	Professor P.K. Kalra Director Dayalbagh Educational Institute Dayalbagh, Agra-282 005
(b)	2. Treasurer (Ex-officio)	Smt. Sneh Bijlani Treasurer Dayalbagh Educational Institute Dayalbagh, Agra-282 005
(c)	3. Principals of the Non- University Technical Educational Institutions (NUTEI) (Ex-officio)	Dr. B.B. Rao Principal DEI Technical College Dayalbagh, Agra-282 005
(d)	4. One teacher from each of the NUTEI not below the rank of lecturer by rotation in order of seniority (Term-One year) 2012-2013 : Sh.V.P. Malhotra	Dr. Purshottam Kumar Lecturer DEI Technical College Dayalbagh, Agra-282 005
(e)	5. Two nominees of the Governing Body from amongst its members (GBR-15 dt.15.12.2012)	Prof V.B. Gupta 3/173, Prem Nagar Dayalbagh, Agra-282 005
	6. -do-	Shri Prem Prashant (IAS Retd.) 3/21, Prem Nagar Dayalbagh, Agra-282 005
(f)	7. Director, Technical Education, Uttar Pradesh. (Ex-officio) 0512-2582084 (O) (M) 9455004691	The Director Technical Education Directorate of Technical Education, U.P. Near Gurdeo Palace Cinema Hall Zoo Road KANPUR-208 002
(g)	8. One nominee of the Northern Regional Office of the All India Council for Technical Education. Ph: 2292550 22929551 2550122 Fax: 0512-2214492	The Regional Officer, NRO All India Council for Technical Education Behind Govt. Polytechnic Near Gurudeo Palace Cinema Hall Zoo Road, Vikas Nagar KANPUR-208 002

- (h) 9. One nominee of the Managing Committee of the Radhasoami Educational Institute of Agra, Dayalbagh, Agra. Shri P. P. Dhir
4/101-102 Vidyut Nagar
Dayalbagh, Agra-282 005
- (i) 10. Two persons, not being members or employees of the Institute including non-university educational institutions to be nominated by the President of the Institute from amongst eminent educationists and technologists. Shri Jamuna Prasad
117, Jairam Bagh,
Dayalbagh, Agra-282 005
11. -do- Shri V. Prem Swarup
3, Dayal Nagar
Dayalbagh, Agra
Phone: Res.: (011) 21738494
Off. : (011) 26148542

RULE:13
ACADEMIC COUNCIL - LIST OF MEMBERS

TERM: 2014-2017 Total Members: 44 Quorum: Ten (As on 1-July-2016)

<u>Status of Nomination</u>	<u>Name of the member</u>
(a) 1. Director (Ex-officio)	Professor P.K. Kalra Director Dayalbagh Educational Institute Dayalbagh, Agra-282 005
(b) 2. Deans of Faculties (Ex-officio) (1.7.2014 to 30.6.2017)	Prof.(Smt.) Ragini Roy Dean, Faculty of Arts Dayalbagh Educational Institute Dayalbagh, Agra-282 005
3. -do- (01-07-2016 to 30-06-2019)	Prof. Satya Prakash Dean, Faculty of Commerce Dayalbagh Educational Institute Dayalbagh, Agra-282 005
4. -do- w.e.f. 27.7.2016 to 26.7.2019	Professor K.C. Vashishtha Dean, Faculty of Education Dayalbagh Educational Institute Dayalbagh, Agra-282 005
5. -do- (1-6-2016 to 31-5-2019)	Prof. S.K. Gaur Dean, Faculty of Engineering Dayalbagh Educational Institute Dayalbagh, Agra-282 005
6. -do- (15.11.2014 to 14.11.2017)	Professor Ravinder Kumar Dean, Faculty of Science Dayalbagh Educational Institute Dayalbagh, Agra-282 005
7. -do- (01-7-2015 to 30-06-2018)	Prof. Soami Prakash Srivastava Dean, Faculty of Social Sciences Dayalbagh Educational Institute Dayalbagh, Agra-282 005
(c) 8. Heads/Incharges of all the teaching departments in the university faculties, who are not Deans.(wef. 2.12.2016)	Prof. Giriraj Kumar Head, Deptt. of Sanskrit Faculty of Arts Dayalbagh Educational Institute Dayalbagh, Agra-282 005
9. -do- (w.e.f. 1.1.15)	Professor J.K. Verma Head, Deptt. of English Faculty of Arts Dayalbagh Educational Institute Dayalbagh, Agra-282 005

10. -do-
(Term upto 20.5.2017) Professor (Smt.) Ravi Sidhu
 Head, Deptt. of Home Science
 Faculty of Arts
 Dayalbagh Educational Institute
 Dayalbagh, Agra-282 005
11. -do- Prof.(Smt.) Sharmila Saxena
 Head, Deptt. of Hindi
 Faculty of Arts
 Dayalbagh Educational Institute
 Dayalbagh, Agra-282 005
12. -do- Professor (Smt.) S.K. Satsangi
 Head, Deptt. of Music
 Faculty of Arts
 Dayalbagh Educational Institute
 Dayalbagh, Agra-282 005
13. -do- Prof. Pramod Kumar
 Head, Deptt. of Accountancy & Law
 Faculty of Commerce
 Dayalbagh Educational Institute
 Dayalbagh, Agra-282 005
14. Heads/Incharges of all the Professor Vibha Nigam
teaching departments in Head, Deptt. of Pedagogical Science
theInstitute faculties, who are Faculty of Education
not Deans. Dayalbagh Educational Institute
 Dayalbagh, Agra-282 005
15. -do- Prof. Ajay Kumar Saxena
 Head, Deptt. of Elect. Engg.
 Faculty of Engineering
 Dayalbagh Educational Institute
 Dayalbagh, Agra-282 005
16. -do-
(from 25.5.2011) Professor Sant Prakash
 Head, Deptt. of Zoology
 Faculty of Science
 Dayalbagh Educational Institute,
 Dayalbagh, Agra-282 005
17. -do-
from 15.1.2016 Professor J.N. Srivastava
 Head, Deptt. of Botany
 Faculty of Science
 Dayalbagh Educational Institute
 Dayalbagh, Agra-282 005
18. -do- Professor Sahab Dass
 Head, Deptt. of Chemistry
 Faculty of Science
 Dayalbagh Educational Institute
 Dayalbagh, Agra-282 005

19. -do-
(From 7.8.2012) Professor G.S. Tyagi
Head, Deptt. of Physics & Comp. Sc.
Faculty of Science
Dayalbagh Educational Institute
Dayalbagh, Agra-282 005
20. Heads/Incharges of all the teaching departments in the university faculties, who are not Deans.
(From 24.10.2015) Dr.(Mrs.) P.K. Mona
Head, Deptt. of Psychology
Faculty of Social Sciences
Dayalbagh Educational Institute
Dayalbagh, Agra-282 005
21. -do-
(from 27.12.2013) Prof. Sanjeev Swami
Head, Deptt. of Management
Faculty of Social Sciences
Dayalbagh Educational Institute
Dayalbagh, Agra-282 005
22. -do- Prof. (Smt.) Poornima Jain
Head, Deptt. of Pol.Sc. & Sociology
Faculty of Social Sciences
Dayalbagh Educational Institute
Dayalbagh, Agra-282 005
23. -do-
(Dept. created from 1.7.2006) Prof.(Smt.)Poornima Jain
Head, Deptt. of LLL&E
Faculty of Social Sciences
Dayalbagh, Agra-5
- (d) 24. One member of the teaching staff, not below the rank of lecturer and not covered by clauses (b) and (c) above from each Faculty in order of seniority by rotation.

(Term- One year: 2016-17) Prof.(Smt.) Renu Josan
Department of English
Faculty of Arts
Dayalbagh Educational Institute
Dayalbagh, Agra-282 005
25. -do-
(Term- One year: 2016-17) Dr.(Ms.) Bhawana Johri
Dept. of Applied Business Economics
Faculty of Commerce
Dayalbagh Educational Institute
Dayalbagh, Agra-282 005
26. One member of the teaching staff, not below the rank of lecturer and not covered by clauses (b) and (c) above from each Faculty in order of seniority by rotation.

(Term- One year: 2016-17) Prof. Savita Srivastava
Dept. of Foundations of Education
Faculty of Education
Dayalbagh Educational Institute
Dayalbagh, Agra-282 005

27. -do- Dr. Ashok Yadav
Dept. of Mechanical Engg.
Faculty of Engineering
Dayalbagh Educational Institute
Dayalbagh, Agra-282 005
(Term- One year: 2016-17)
28. -do- Prof. Shalini Srivastava
Dept. of Chemistry, Faculty of Science
Dayalbagh Educational Institute
Dayalbagh, Agra-282 005
(Term- One year: 2016-17)
29. -do- Dr. (Km.) Jyoti Gogia
Dept. of Economics, Faculty of Social Sciences
Dayalbagh Educational Institute
Dayalbagh, Agra-282 005
(Term- One year: 2016-17)
- (e) 30. The Coordinator
Distance Education Cell
Prof. V.B. Gupta
Distance Education Cell
Dayalbagh Educational Institute
Dayalbagh, Agra-282 005
- (e) 31. Principals of all the non-
university educational
institutions
Dr. B.B. Rao
Principal, DEI Technical College
Dayalbagh, Agra-282 005
32. -do- Dr. (Mrs.) Mala Bal
DEI P.V. Girls' Intermediate College
Dayalbagh, Agra-282 005
33. -do- Dr. R.B. Dixit
Principal, REI Intermediate College
Dayalbagh, Agra-282 005
34. Principals of all the non-
university educational
institutions
Sh.D.S. Kapoor
Principal Incharge
Radhasoami Adivasi Higher Secondary School
C/o Manager, Rajaborari Estate
TIMARNI Dist. HARDA (MP)-461228
35. -do- Anita Kheterpal
Principal, Soami Nagar Pre-Primary School
C-33, Second Floor, Soami Nagar (North)
NEW DELHI-110 017
36. -do- Mrs. Arti Prasad
Principal, Soami Nagar Model School
(Primary) Soami Nagar (North)
NEW DELHI-110 017
- (f) 37. -do- Ms. Usha Tiwari
Principal, Roorkee Model School
23B, Dayalbagh Colony
Ganeshpur (Near Railway Station)
ROORKEE-247 667

- | | | |
|-----|---|---|
| (g) | 38. The Director of Technical Education, Uttar Pradesh (Ex-officio)

0512-2582084 (O)
(M) 9455004691 | The Director
Technical Education
Directorate of Technical Education, U.P.
Near Gurdeo Palace Cinema Hall
Zoo Road
KANPUR-208 002 |
| (h) | 39. One nominee of the Chairman, University Grants Commission | As per UGC Regulations, 2010
No nomination from UGC |
| (i) | 40. Two specialists in Industry, to be nominated by the Governing Body
(GBR-2 dt.7.5.2011)
Tel:(M) 9810212311
011-26145396 (R)
Fax:011-26146691
rajivsinha@gmail.com | Shri Rajiv Sinha
Senior Advisor
DCM Sriram Ltd.
A-14/14, Vasant Vihar
New Delhi-110 057 |
| 41. | -do-
Phone +91-11-22751573
email: prempsri@gmail.com
Mob. 09810055226 | Shri P.P. Srivastava
33, Manu Apartments
Mayur Vihar Phase-I
Delhi- 110091 |
| (j) | 42. Not more than five persons of eminence in the fields of Arts and Culture, Commerce, Education, Engineering and Science, to be nominated by the Governing Body
(GBR- dated) | Professor P. Sriramamurti
4/112, Vidyut Nagar
Dayalbagh, Agra-282 005 |
| 43. | -do-

Tele. 26498241
51050001
Mob. 9810153341
pami.dua@gmail.com | Professor Pami Dua
C-58, Soami Nagar
NEW DELHI-110 017 |
| 44. | -do- | Prof. R.N. Mehrotra
3/189, Prem Nagar
Dayalbagh, Agra-282 005 |
| 45. | -do- | Prof. Jamuna Prasad
117, Jairam Bagh, Dayalbagh, Agra |
| 46. | -do-
pkalra@cse.iitd.ac.in
mob. 9452831015 | Professor P.K. Kalra
Department of Computer Science
Indian Institute of Technology
Hauz Khas, New Delhi-110016 |

ANNEXURE FOR PARTICIPATION IN CONFERENCES/SEMINARS

S.N.	Name	Title	Organized by	National/ International
1	Prof. Kamlesh Kumari Ravi	Matri Bhasha Diwas Programme	Programme co-ordinator D.E.I (Deemed University) Dayalbagh Agra	National
2	Prof. Kamlesh Kumari Ravi	Samkalin Vimersh	Organaiser D.E.I (Deemed University) Dayalbagh Agra	National
3	Prof. Kamlesh Kumari Ravi	Janbhasha ke Bina Jantantr Adhura	K.M.I Bhasha Vigyan Vidhyapeeth, Dr.B.R.A. Uni. Agra, C.H.I Agra orgnaise by ugc 7 days international workshop	International
4	Dr. Namasya	Sahitya Kala Aur Naitikta	Bhartiya Bhashaon ke Sahitya mein Bhartiya Mulya conducted by Jainarayan Vishvavidyalaya - Jodhpur-	National
5	Dr. Namasya	Bhasha Manviya Asmita ki Pahchan-	Hindi Bhasha ke Vikas mein anya Bhartiya Bhashaon ka yogdan conducted byvivekanand Gramodhyog mahavidyalaya-dibiyapur-Aurayya	International
6	Akriti Shakya , Charu Swami	Designing Khadi Kurtis inspired from Mughal Silhouettes for contemporary women wear	MSU, Baroda & Consortium of Green Fashion, SOFT, Pune.	Inter-national
7	Akriti Shakya, Charu Swami	Refashioning Apparel Waste: A Review	Amity University, Noida	Inter-national
8	Sonika,	A creative Expression of Life in association with Nature- the Warli Painting	Department of Drawing & Painting, Faculty of Visual Arts, Kumaun University – Nainital	National
9	Dr. Sonal Singh	The Illusion of Perceiving Reality : A Study of Luigi Pirandello’s “Six Characters in Search of an Author”	The Science of Consciousness (TSC, 2017), San Diego, California USA, 5-10 June 2017.	International
10	Dr. Sonal Singh and Tanushree Kulshreshtha	The Intricacies of Pursuing Research in Regional Literature	National conference on Pre-Doctoral Research [MDNCPDR-2017], Dayalbagh Educational Institute , February 12-13, 2017	National

11	Meghana Middha	“Breaking the Socio Cultural Norms: Gender and Identity in Radclyffe Hall’s <i>The Well Of Loneliness</i> and Rita Mae Brown’s <i>Ruby Fruit Jungle</i> ”	Euroademia sixth International conference on ‘Identities and Identifications’ held in Florence, Italy on 22 nd and 23 rd of June 2017.	International
12	Yashvi Manglik	The Bhagavadgita: A Study From Literary perspective	One-Day National Seminar on New Horizons In Linguistic, Literary and Cultural Studies, February 2017	National
13	Vidhi Jalan	Portrayal of East in the Western Films	One-Day National Seminar on New Horizons In Linguistic, Literary and Cultural Studies, February 2017.	National
14	Dr.Madhulika Gautam	Innovative Approaches in Applied Sciences and Technologies	Scientific Educational Research Society Meerut 250004 India and Faculty of Science, Kasetsart university Bangkok 10900 Thailand	International
15	Dr.Madhulika Gautam	Differential Knowledge regarding Breast Feeding among ICDS (Integrated Child Development Services) Beneficiary and Non Beneficiary Women Living in Rural and Urban Areas of Agra District	Scientific Educational Research Society Meerut 250004 India and Faculty of Science, Kasetsart university Bangkok 10900 Thailand	International
16	Prof. Nandita Satsangee	‘Rural and Tribal Empowerment through Technology: DEI Initiatives	IEEE Region 10 Humanitarian Technology Conference,	International
17	Prof. Savita Srivastava	Issues and Challenges Confronting Higher Education: A Road Map for Future’	The International Gandhi Jayanti Conference, 2015 on the theme of Education as a Basic Right of Humankind	International
18	Prof. Sona Dixit	E-Governance and the common man	International Seminar of Advocates on Information technology, Law and Governance at Bangalore Organized by Union International Des Avocats International Association of Lawyers, France.	International
19	Ms. Jyotika Kharbanda	Upliftment of Transgenders Through an Educational Ladder	National Seminar on Current Initiatives in Higher Education	National

20	NupurRaghav and J. N. Shrivastava	Development and Formulation of effective Bacterial Consortium for Sustainable Development	Water Resources National conference on Biotechnology Resource Management for Sustainable Nature In 21 st Century	National
21	Neha Pandey and Shashi Pandey-Rai	Increased In-Planta Production of Artemisinin From <i>Artemisia annua</i> L., An Antimalarial Plant	International conference on Medicinal Plants & Management of Lifestyle Diseases at IAS, BHU, Varanasi from December	National
22	Deepika Tripathi, Neha Pandey and Shashi Pandey-Rai	Thin cell layer technique for rapid in vitro propagation of <i>Withania coagulans</i> , a highly endangered medicinal herb	National conference on Advances in Tissue culture and micropropagation (PTCA) at CSIR-NBRI, Lucknow	National
23	Neha Pandey	Generation of salt tolerant somaclonal variant and development of high artemisinin-linked SCAR marker in <i>Artemisia annua</i> L., an antimalarial plant	104 th Indian Science Congress (Young Scientist Award Lecture) at SV University, Tirupati,	National
24	Neha Pandey and Shashi Pandey-Rai	Early responses to UV-B exposure involve quick activation of acclimation mechanism through adjusting primary and secondary metabolism in <i>Artemisia</i>	National Symposium on Issues & Challenges in Ecological Sciences at Dept of Botany, BHU	National
25	Ms. Sonal Kumari	Enhancement in surface ozone levels at a suburban site associated with crop residue burning in Indo-Gangetic Plain: A case study	Space Applications Centre, Ahmedabad,	National
26	C. Vasantha Lakshmi	--	IEEE Humanitarian Technology Conference	International
27	Preetam Pyari and Soam Prakash	Microcosm & Macrocosm- a Relationship Study on Quantum Consciousness.	TSC2017, June 5-10, 2017. La Jolla, California	
28	Preetam Pyari and Soam Prakash	The Science of Quantum Soul and a New Theory of Consciousness Study	TSC2017, June 5-10, 2017. La Jolla, California	
29	Dr. Sangeeta Kumar	Ideas of Swami Vivekananda in Context of Indian Economy	International Conference on New Frontiers of Engineering, Science, Management and Humanities (ICNFESMH-2017) at The Institution of Electronics and Telecommunication Engineers, Janakpuri, New Delhi,	International

30	Dr. Sangeeta Kumar	Mr. Narendra Modi and Indian Economy: Status and Challenges	International conference on research in Engineering, Applied Science and Management (ICRTESSM-2017) at mahatma chamber of commerce industries and agriculture, Senapati Bapat road, Pune,	International
31	Dr Resham Chopra	A Study of Environment Disclosure Patterns of Indian Companies	Udur Research Model, conference proceedings, Excel Books,	National
32	JaspreetKaur, AnoopSrivastava, Sanjeev Swami, SumitaSrivastava	Integrated Traffic Project Management at Dayalbagh,	IEEE R10 Conference, DEI,	International
33	S. Swami and V. Ramani	Price Premium Effects in Green Supply Chain Management: Modeling and Analysis,	IIITM Gwalior,	International
34	Kanchan Aswani and Sanjeev Swami	Analysis of Sustainability Reporting of Indian Companies, Proceedings of International Conference on Strategies in Volatile and Uncertain Environment for Emerging Markets	DMS IIT Delhi.	International
35	Prof. SK Sharma	Revival of the 'Golden Bird': A Gap Analysis of Governments Initiatives and Tourist Expectations in Uttar Pradesh using Systems Approach'	India Commerce Conference of Indian Commerce Association,	National
36	Sumita Srivastava, Kanika and Nandita Satsangee,	What Affects Entrepreneurial Intentions of Young Women in India?: Current Status and the Way Forward' during the Stand-up India	The National Institute for Entrepreneurship and Small Business Development (NIESBUD), Ministry of Skill Development and Entrepreneurship, Govt. of India	National
37	Sumita Srivastava and Anjul Dayal	'Impact of Surat Shabda Yoga on Organizational Citizenship Behaviour of Employees: A Multi Method Analysis	Centre for Consciousness Studies, University of Arizona, at San Diego, USA	International
38	Dr. Jaspreet Kaur	Developing an early warning signal: Financial Stability Index	Global Trends in Business & Sustainability Research, held on December 2-4, 2016, held at IIT Rourkee	International

39	Dr. Jaspreet Kaur	Perception of tax Payers' Towards GST: A Fiscal and Social Psychology Model Approach	All India Accounting Conference & International Seminar on Accounting Education and Research,	International
40	Shweta Chaturvedi and Preet Kumari	Contribution of Positive cognition emotion strategies	International Conference of Indian Academy of Health Psychology,GBTU	International
41	Dr. Anjali Seth	Kautilya ke ArthaSastra Mein Lok Prashashan ke Tatva	Department of Sociology, BHU. Varanasi	National
42	Prof. Bandana Gaur	Feminism Perspective & Women Relationship in Protective Environment	BIJIE&MS, Tiruvannamalai,	National
43	Prof. Bandana Gaur	Development of Rural women : Entrepreneurs in India	Vansthali Vidyapeeth	National
44	Prof. Bandana Gaur	Human Rights and Women Rights	ESS, College of Education	National

LIST OF PUBLICATIONS 2016-17

Faculty of Arts				
S. No.	Name	Department	Title	Journal
1	Meenakshi Thakur	Drawing & Painting	Mithila- A Globalized Art Form” (IJRG17_A02_105)	International Journal Of Research – Granthaalayah A Knowledge Repository ISSN-2350-0530(O) ISSN- 2394-3629 (P) Feb-2017
2	Sharmila Saxena	Hindi	Abhimanyu annat ke upanyaso mein vyakt nari	Anusandhan-Issn-0975-850X, Aligarh
3	Sharmila Saxena	Hindi	Bharat bhushan agarwal- utna wah suraj hai mein vyakt samkalin yathart	Vangmaya ,ISSN 0975-8321, Aligarh
4	Sharmila Saxena	Hindi	Munshi premchan ki kahaniyo mein vyakt baal abhiruchi	Shodh disha ,Issn-NO 0975-735X , Bijnor
7	Suman Sharma	Hindi	Stri Jeevan Mouritious Ke Sambandh Mein	Satsai Sahitya Mein Ritu Varnan Shodh, 2016
8	Suman Sharma	Hindi	Manav aur Prakriti	Suvarna,2016, pp 47-48
9	Namasya	Hindi	Bhasha Manav Astitva ka prashn	Creative Space-International Journal-Multi lingual and Multi disciplinary-ISSN-2347-1689-Impact factor 0.339.JAN TO FAB 2016, Page-69-72.
10	Prem Shankar	Hindi	Samajhna Aur Jeeana Chahta Hoon Sach	Anhad Patrika, Issn-2248-9053, 2017allahabad
11	Dayal Pyari Sinha	Hindi	Badalta Bhartiya Paridrishya Aur Swatantratayottar Hindi Natak	SahityaSanchay, ISBN978.93.82597.50 pp:220-228 Delhi
12	Charu Swami, Aakriti Shakya	Home Science	Development of Zero-Waste Fashion Design Practices: A Literature Review	Power Publishers, ISBN:978-93-84923-15-0 Kolkata.
13	Shruti Kushwaha, Charu Swami	Home Science	Upcycling Of Leather Waste To Create Upcycled Products And Accessories	International Journal of Home Science, Volume-2, Issue-2, ISSN: 2395-7476 Impact factor- 5.3 (2016)
14	Amita Singh ,Charu Swami	Home Science	Utilization Of Waste Flowers As A Potential Source Of Natural Dyeing On Bamboo Fabric Using Natural Mordents	International Journal of Research in Advent Technology Volume-4, Issue-6, ISSN: 2321-9637 Impact factor- 5.15 (June 2016)

15	Sadaf Khan, Charu Swami	Home Science	Developing And Creating Contemporary Textile Designs Inspired From Selected Mughal Monuments Of Agra	International Journal of Education and Science Research Review ISSN: 2348-6457 Impact factor- 2.816 ,(Volume-3, Issue-3 2016)
16	Sharma, R. and Goel, A.	Home Science	Analysis of Insect Repellent Behaviour of Eucalyptus Oil and Cedar Wood Oil towards Lepisma saccharina	2017
17	Singh A, Verma R	Home Science	Unplanned Journey of Parenting a Child with Special Needs	Paripex - Indian Journal Of Research Volume : 6 Issue : 3 ISSN - 2250-1991 IF : 5.761 IC Value : 79.96, 581-583
18	Singh A, Verma R	Home Science	Science and Technology: A Boon for Special People”.	Asian Journal of Science and Technology (AJST). Volume-7 Issue-6 ISSN 0976-3376, 3022- 3026, 2016
19	Sarna P, Verma R	Home Science	Analyzing and comparing temperament among middle and late adolescents with respect to educational index	International Journal of Home Science, Volume-2 Issue-1 , ISSN Number: 2395- 7476 Impact Factor: RJIF 5.3108-110, 2016
20	Hemlata Chand & Dr.Seema Kashyap	Home Science	Dysfunctional Families: The Foundation and Upshot of Female Criminality in India.	International Journal of Science and Research, 2319-7064 1346-1347
21	Ajita Gupta &Dr.Seema Kashyap	Home Science	Awareness regarding procedure of filing and pursuing complaints in district consumer redressal forum	International Journal of Home Science, 2395-7476, 219-222, 2016
22	Verma R	Home Science	Computer Assisted Instruction (CAI): An Innovative Approach for individualized Education	International Journal of Research in Social Science (IJRSS) Volume-6, Issue-12[ISSN – 2249-2496] Impact Factor: 6.278 for 2015 pp.136-146 December, 2016
23	Mehtab, S., Gahlot, M. and Rani, A.	Home Science	Application of Justicia Adhatoda L. leaf extract as antimicrobial finish on cotton fabric	International Journal of Basic and Applied Agricultural Research. Vol. 14(2) ISSN0972- 8813:

24	Chaudhary, C., Khatak, A, Reena Devi, Yadav, B.S. and Deepti Rai	Home Science	Study of fermentation variables for the preparation of wine from jamun fruit	Journal of pure & applied Microbiology. 11(3). 2017
25	Aakriti Agrawal	English	“Gender and Sexuality in Contemporary Indian and Pakistani Films with special reference to Deepa Mehta’s Water and Shoaib Mansoor’s Bal”	The Atlantic Review of Feminist Studies Volume 4 No. 3 & 4 [ISSN No. 2320-5105] 2017.
26	Meghana Middha	English	“Relocating Heterosexuality: The Search for the Self in Sandeep Roy’s Don’t Let Him Know and Patricia Highsmith’s The Price of Salt”	The Atlantic Review of Feminist Studies Volume 4 No. 3 & 4 [ISSN No. 2320-5105] 2017
27	Gur Pyari Jandial and Avneet Kaur	English	“The Epical Saga of J.R.R. Tolkien’s The Lord of the Rings as Fantasy Fiction”	The Atlantic Critical Review Vol. 16 No.2 [ISSN No. 0972-6373] 2017.
28	Sonal Singh	English	An Exuberant Odyssey: Bacon’s Tips to Travellers.	Lachoo Management Journal (Volume 7, Number 1/ January – June, 2016)
29	Tanushree Kulshreshtha	English	Indian Woman: Her Status in Society and its reflection in Literature with special reference to Vijay Tendulkar’s Silence! The Court is in Session.	BIMB A Refereed E-Journal of Creative Art and Literature. September 2016.
30	Yashvi Manglik	English	From Spirituality to Psychology: The Study of The Bhagavadgita from the Perspective of Cognitive Behavioral Therapy	Daath Voyage: An International Journal of Interdisciplinary Studies in English (ISSN NO. 2455-7544) Date: 22 nd April 2017
31	Kumar, G. and Robert G. Bednarik	Sanskrit	Emergency closure of Daraki-Chattan Cave.	Purakala 26: 65-68.
32	Kumar, G., Ram Krishna and Robert G. Bednarik	Sanskrit	Taphonomy of the early petroglyphs at Daraki-Chattan and in the region around it in Chambal basin, India	Palaeoart and Materiality: The Scientific Study of Rock Art, pp.161-170. Oxford England: Archaeopress Publishing Ltd. 2016

33	Ram Krishna and G. Kumar	Sanskrit	Understanding the technology of very small cupules in Daraki-Chattan, India.	Palaeoart and Materiality: The Scientific Study of Rock Ar, pp.187-194. Oxford England: Archaeopress Publishing Ltd.
34	Manju Rani Bhatnagar	Sanskrit	Upnishad Kaleen Shiksha Paddhati	Shodh Pratibha, pp: 109-116,2016
35	Sangeeta Kumari	Sanskrit	Bhoutiktavaad ki aur badte yuvaon ke kadam	Shiksha Shodh,pp:26-28
Faculty of Education				
36	Kailasha Chandra Vashishtha	Foundation of Education	Modules for enhancement of Quality Education: A Triangular Package	Pedagogy & Constructivism; NCERT, 2017
37	Kailasha Chandra Vashishtha	Foundation of Education	The effect of Life Skills on Decision-making skills of Dyscalculic students,	Vol.XLII, no. 3, Nov 2016, Journal of Indian Education, NCERT, New Delhi, ISSN 0377-0435
38	Savita Srivastava	Foundation of Education	Ethics and Accountability of a Teacher for Environment Friendly Behaviour & Sustainability'	International Journal of Engineering Research and Management (IJERM), ISSN: 2349- 2058, January 2016, Pp 15-18.
39	Savita Srivastava	Foundation of Education	Digital India & Social Welfare Administration: A New Dawn in India	I International Journal of Trend in Research and Development, IJTRD, Impact Factor: 2.010, Volume 3 (1), ISSN 2394-9333,Jan - Feb 2016, www.ijtrd.com , Pp 102-109.
40	D.Vasanta	Foundation of Education	Comparative Study of Religions A message of Love and Peace	International Journal For Innovative Research In Multi Disciplinary Fields, Vol.-2, Page no.- 271 to 274, year-2016
41	Dixit, S.&Gautam,R.	Foundation of Education	A Study Of Discriminatory Practices Based on Gender Perceived by Secondary School Students of Agra District	AE International Journal of Multidisciplinary Research, Vol 5 ,(06), pp 1-7. Impact Factor- 2.72.2017
42	Pandey,K.	Foundation of Education	Handbook of Research on Promoting Global Peace and Civic Engagement through Education	An international edited book Published by IGI Publication, USA,2016

43	Bhushan, Bajrang	Foundation of Education	Role of IT for Distance Learners	Pahal Horizon, Vol.1 (1), pp.43-46, 2016.
----	------------------	-------------------------	----------------------------------	---

Faculty of Science

44	Nupur Raghav and Shrivastava, J.N.	Botany	Toxic Pollution in River Water and Bacterial Remediation: An Overview.	International Journal Of Current Microbiology And Applied Sciences. 5(4): 244-266. (International) (I.F-2.93),2016
45	Anshu Singh ,J.N.Shrivastava and Anil Kumar	Botany	Phytotoxicity of citrus fruit waste against human pathogenic bacteria.	International Journal Of Pharma Science Research 7(8):3366-72
46	Anshu Singh, JanendraNathShrivastava and NidhiGovil	Botany	Existence of keratinophilic fungi in the soils of Hilly and Plain Areas	International Journal of Research, December 2016
47	Richa Saxena, J. N. Shrivastava and Parul Saxena	Botany	Degradation of Feather keratin by Keratinophyles for Growth Promoting Biomolecules: A Biochemical Proof	International Journal of Research, December 2016
48	Dantu P. K., Khaitwar A. and Bhojwani S. S.,	Botany	.Pollen-Pistil interactions: Biochemical and Molecular Insights- A Review.	The Intern. J. Plant Repro. Biol. 8:.56-64, DOI 10.14787/ijprb.2016 8.1.56-64
49	Dantu P. K., Arti Yadav and Sapana.	Botany	Influence of low temperature treatment and phytohormones on regeneration through anther culture in two cultivars of rice.	The Intern. J. Plant Repro. Biol. 9(1), pp.65-66, DOI 10.14787/ijprb.2017 9.1.65-66
50	Mamta, Harshda, Nupur Raghav, J N Shrivastava, G P Satsangi, P Jain and Ranjeet Kumar	Botany	Biogenic Constituents of Respirable Aerosol over Semiarid Region	Journal of chemical, Biological and Physical Sciences, October 2016
51	Anamika Gupta, D. Sarveshwara Rao and G.P. Satsangi	Botany	Impact of pendimethalin on mitotic index and root growth inhibition of Allium cepa (L.)	Indian Journal of Applied Research 2016
52	Yati Prabha, Arti Tyagi and S.K. Soni	Botany	Impact of Monosodium glutamate on the	Int. J. Pure App. Biosci. 4 (1): 180-184.[SJIF = 4 & ISF= 1.2],2016

			production and chemical constituents of <i>Spirulinamaxima</i>	
53	Yati Prabha, S.K. Soni, Sharmita Gupta and Sonal	Botany	Potential of Algae in Bioremediation of Wastewater: Current Research	Int.J.Curr.Microbiol.App.Sc.5 (2): 693-700. [IF= 2.937]
54	Yati Prabha, S.K. Soni and Chitransha Singh	Botany	Variations in cellular metabolites of <i>Spirulina maxima</i> Geitler cultivated under Semi arid climatic conditions of Agra	Journal of Agricultural Engineering and Food Technology Vol 3, Issue 1:28-30.
55	Yati Prabha, S.K.Soni and Chitransha Singh	Botany	Potential of <i>Spirulina maxima</i> in the Bioremediation of waste water.	International Journal of Research Volume 3, Issue 01:176-180 [IF = 3.54]
56	Yati prabha, S.K.Soni, Sharmita Gupta and Sonal	Botany	Potential of algae in bioremediation of waste water, currentresearch	International Journal of Current microbiology and applied sciences 5(2):693-700.
57	Priyanka Baghel and Sharmita Gupta	Botany	Status of municipal authority and public cooperation for solid waste management: A case study in Dayalbagh area Agra	International Journal of Research 3 (18):1134-1144
58	Dipinte Gupta and Rajiv Ranjan	Botany	Role of Bamboo in Sustainable Development.	International Journal of Advances in Scientific Research and Reviews (IJASRR). 2(1) 2016,25-32
59	Gupta, D., <u>Ranjan, R.</u> , Saxena, S. P.	Botany	Parthenium Grass: Is it curse to the society?	International Journal of Advances in Scientific Research and Reviews (IJASRR). 2(2) 2016, 33-50
60	Dipinte Gupta & <u>Ranjan R</u>	Botany	Genetic Diversity Analysis of Chick Pea Using Seed Protein Profiling.	International Journal For Innovative Research In Multidisciplinary Field. 2016, 129-1409.
61	Dipinte Gupta and Ranjan R.	Botany	In-Silico comparative Analysis of Promoters derived from Plant Parareteroviruses.	Virus Disease (Accepted) DOI:10.1007/s13337-017-0410-8.
62	Mishra S and Khurana J.P	Botany	Emerging Roles and New Paradigms in Signaling Mechanisms of Plant Cryptochromes	Crit. Rev . Plant Sci: 36 (2): 89-115,2017

63	Bollinedi H, Krishnan G, Prabhu KV, Singh NK, Mishra S, Khurana JP and Singh AK.	Botany	Molecular and Functional Characterization of GR2-R1 Event Based Backcross Derived Lines of Golden Rice in the Genetic Background of a Mega Rice Variety Swarna	PLoS ONE 12 (1): e0169600. doi:10.1371/journal.pone.0169600,2017
64	Kumar, A., Attri, A.K.	Botany	Characterization of fungal spores in the ambient particulate matter: A study from the Himalayan region.	Atmospheric Environment (2016)142, 182-193. doi:10.1016/j.atmosenv.2016.07.049. Impact Factor 3.629.
65	Kumar, A., Attri, A.K.	Botany	Biomass Combustion on a Dominant Source of Carbonaceous Aerosols in the Ambient Environment of Western Himalayas.	Aerosol Air Qual Res (2016) 16, 519-529. doi:10.4209/aaqr.2015.05.0284. Impact Factor 1.637.
66	Kumar, A., Attri, A.K.,	Botany	Correlating respiratory disease incidences with corresponding trends in the ambient particulate matter and relative humidity	Atmospheric Pollution Research (2016), 7, 858-864. http://dx.doi.org/10.1016/j.apr.2016.05.005. Impact Factor 2.606.
67	Anant Gopal Singh, Akhillesh Kumar*,	Botany	Ethnomedicinal aspects of climbing plants of Palpa district, Nepal	Tropical plant Research 4(2): 307-313
68	R.K. Fagodiya, H. Pathak, A. Kumar, A. Bhatia and Jain	Botany	Global temperature potential of nitrogen use in Agriculture: A 50-year assessment	Scientific Report Nature 7: 44928; doi: 10.1038/srep44928 Impact Factor=5.2 2017
69	A. Kumar, S. Mishra, A. Kumar, S. Singhal	Botany	Environmental Quantification of Soil Elements in the catchment of Hydroelectric Reservoirs in India	Human and Ecological Risk Assessment (Accepted) Impact Factor= 1.34 2017
70	S.K. Malyan, A. Bhatia, A. Kumar, R. Singh, S.S. Kumar, R. Tomer, O. Kumar, D.K. Gupta, N Jain	Botany	Methane production, oxidation and mitigation: A Mechanistic understanding and comprehensive evaluation of influencing factors	Science of Total Environment. http://dx.doi.org/10.1016/j.scitotenv.2016.07.182 Impact Factor=3.9

71	D.K. Gupta, A. Bhatia, A. Kumar, T K Das, N. Jain, R. Tomer, R.K. Fagodiya, R. Dubey, S K Malyan and H. Pathak	Botany	Mitigation of greenhouse gas emission from rice wheat system of the Indo Gangetic plains: through tillage, irrigation and fertilizer management	Agriculture, Ecosystems and Environment. 230:1-9 Impact Factor=3.5
72	A. Kumar, M. P. Sharma, A. Kumar	Botany	Green House Gas emissions from Hydropower Reservoirs: Policy and Challenges	International Journal of Renewable Energy Research 6, 472-476. Impact Factor=1.21
73	S. S. Kumar, S.K. Malyan, A. Kumar and N.R. Bishnoi	Botany	Optimization of fenton's oxidation by box-behnken design of response surface methodology of landfill leachate	Journal of Material & Environment Science 7(12) 4456-4466. Impact Factor=1.23
74	D.K. Gupta, A. Bhatia, T.K. Das, P. Singh, A. Kumar, N. Jain and H. Pathak	Botany	Economic analysis of different greenhouse gas mitigation technologies in rice-wheat cropping system of the Indo-Gangetic Plains	Current Science 110(5) 867-873. Impact Factor=0.89
75	H. Pathak, N. Jain, A. Bhatia, A. Kumar and D. Chatterjee	Botany	Improved Nitrogen Management: A key to climate change adaptation and mitigation	Indian Journal of fertilizers, 12(11) 151-162.
76	Pandey N, Meena RP, Rai SK, Pandey-Rai S	Botany	In-vitro generation of high artemisinin yielding salt tolerant somaclonal variant and development of SCAR marker in Artemisia annua L. Plant Cell Tissue and Organ Culture	Journal Of Plant Biotechnology. 127(2):301-314. (IF= 2.002).
77	Kumari A, Pandey Nand Pandey-Rai S	Botany	Protection of Artemisia annua roots and leaves against oxidative stress induced by arsenic	Biologia Plantarum.61 (2): 367-377.
78	Kumari A, Pandey Nand Pandey-Rai S	Botany	Exogenous salicylic acid-mediated modulation of arsenic stress	Protoplasma. DOI: 10.1007/s00709-017-1136-6

			tolerance with enhanced accumulation of secondary metabolites and improved size of glandular trichomes in <i>Artemisia annua</i> L	
79	Kumari A, <u>Pandey N</u> , Meena RP, Tripathi D and Pandey-Rai S	Botany	In-vitro characterization of somaclonal variant against salt tolerance by analyzing antioxidative defense system and secondary metabolites in <i>Artemisia annua</i> L.	International Journal of Pharma and Bio Sciences. 7(2): (B) 700 – 714.
80	Arora N, Tripathi D, <u>Pandey N</u> , Rai KK, Rai SK, Pandey-Rai S	Botany	Study of Antioxidant, Anti-inflammatory, and DNA-Damage protection Properties of Some Indian Medicinal Plants Reveal their Possible Role in Combating Psoriasis	International Journal of Applied Science and Biotechnology. Doi: 10.3126/ijasbt.v5i2.xxxxx
81	Rai SK, Rai KK, <u>Pandey N</u> , Kumari A, Tripathi D and Pandey-Rai S	Botany	Varietal performance of turmeric (<i>Curcuma longa</i> L.) with special reference to curcumin and essential oil content under climatic conditions of Indogangatic plains.	Indian Journal of Vegetable Science 43 (1) : 36-43,2016
82	Akbar Ali, M. Masroor A. Khan, Naeem M, Idrees M, Dar TA, Moinuddin, Dan tu PK, Singh TB	Botany	Nutrient uptake, removal and cycling in Eucalyptus species. In: Essential Plant Nutrients: Uptake, Use Efficiency, and Management. Naeem, M, Ansari AA, Gill SS (Eds.).	Springer International Publishing AG, Switzerland.
83	J Mukherjee, N. Mridha, S. Mondal, D.	Botany	Management of soil health in variable climate	Advances in crop environment interaction” (Ed; S. K. Bal et. al.).

	Chakraborty and A. Kumar			(Accepted).
84	A. Kumar, P. Das, J. Mukherjee, A. Das, N. Mridha, P. Santra and D. Chakraborty	Botany	Digital soil mapping"	edited in "Digital soil mapping through geostatistical approaches using R and QGIS (Ed; Priyabrata Santra et al.,) under the publication of NIPA, New Delhi (Accepted).
85	Mishra S, Gupta D and Ranjan R	Botany	Molecular approaches for enhancing stress tolerance in plants. In: Approaches for enhancing abiotic stress tolerance in plants. (Eds; Hasanuzzaman et al).	Taylor and Francis Group, Florida, U.S.A. (Accepted In-press).
86	Anamika Banerjee, Biswajit Mondal, Anuradha Verma, Vibha R. Satsangi, Rohit Shrivastav, Abhishek Dey, Sahab Dass	Chemistry	Enhancing Efficiency of Fe ₂ O ₃ for Robust and Proficient Solar Water Splitting by Using Highly Dispersed Bioinspired Catalyst	Journal of Catalysis, 352, 83-92, 2017. [Impact Factor: 7.35]
87	Nidhi Verma, Aparna Satsangi, Anita Lakhani, K. Maharaj Kumari.	Chemistry	Diurnal, Seasonal and Vertical Variability in Carbon Monoxide levels over a semi-urban site in Indo-Gangetic Plain.	Clean- Soil, Air and Water, 45, 1-9, 2017. [Impact Factor: 1.71]
88	Nidhi Verma, Aparna Satsangi, Anita Lakhani, K. Maharaj Kumari	Chemistry	Low Molecular weight Monocarboxylic Acids in P _{M2.5} and P _{M10} : Seasonal Variation and Source Apportionment	Aerosol Air Quality and Research, 17, 485-498, 2017.[Impact Factor:2.51] Cited by 2
89	A. Sen; A.S. Abdelmaksoud; Y. Nazeer Ahammed; Mansour A. Alghamdi; TirthanKar Banerjee;	Chemistry	Variations in particulate matter over Indo-Gangetic Plains and Indo-Himalayan Range during four field campaigns in winter monsoon and	Atmospheric Environment, 154, 200-224, 2017. [Impact Factor: 3.45] Cited by 2

	Mudasir Ahmad Bhat; A Chatterjee; Anil K. Choudhari; Trupti Das; Amit Dhir; Ranu Gadi; Sanjay Ghosh; A.H Khan; M. Khoder; K. Maharaj Kumari; Jagdish Chandra Kuniyal; Manish Kumar; Anita Lakhani; Parth Sarathi Mahapatra; Manish Naja; Dharam Pal Singh; S Pal; Mahammad Rafiq; Shakil Ahmad Romshoo; Irfan Rashid; Prasenjit Saikia; D.M. Shenoy; Vijay Sridhar; Nidhi Verma; B. M. Vyas; Mohit Saxena; A Sharma; S.K. Sharma. Tuhin Kumar Mandal.		summer monsoon: Role of pollution pathways.	
90	Priyanka Jain, Shilpa Varshney and Shalini Srivastava	Chemistry	Application of Nitrogen-Enriched Nanobiopolymer for Effective Removal of Cr(VI) from Tannery Effluent	Separation Science Technology, DOI:10.1080/01496395.2017.1295993, 2017. [Impact Factor: 1.08]
91	Divya Gautam, Sachin Saxena, Ajay Kumar and S.K. Verma	Chemistry	Activated sugarcane bagasse ash (ASBA): Studies on its properties for adsorption of sugar colour	International Journal of Applied Sciences and Technology, 5, 65-75, 2017. [Impact Factor: 1.582]
92	Dipika Sharma, Biswarup Satpati, Vibha R. Satsangi,	Chemistry	Electronic Band-offsets across Cu ₂ O/BaZrO ₃ Heterojunction and	DOI:10.1016/j.renene.2017.06.022, 2017. [Impact Factor: 3.4]

	Rohit Shrivastav, Umesh V. Waghmare and Sahab Dass		its Stable PhotoElectro-Chemical Response: First-principles Theoretical Analysis and Experimental Optimization, Renewable Energy,	
93	Pratima Gupta, Shailendra Pratap Singh, Ashok Jangid and Ranjit Kumar.	Chemistry	Measurements and characterization of black carbon in ambient air of city of Taj over Indo-Gangetic: seasonal variation and meteorological influence,	Advances in Atmospheric Sciences, DOI: 10.1007/S00376-017-6234-Z, 2017. [Impact Factor: 1.3]
94	Awni Agarwal, Ankita Mangal, Aparna Satsangi, Anita Lakhani, K. Maharaj Kumari	Chemistry	Characterization, Sources and Health Risk Analysis of PM _{2.5} bound Metals during Foggy and Non-foggy days in Sub-urban Site of Agra	Atmospheric Research, 197, 121-131, 2017. [Impact Factor: 3.377]
95	Nidhi Verma, Anita Lakhani, K. Maharaj Kumari	Chemistry	High Ozone Episodes at a Semi-urban Site in India: Photochemical Generation and Transport.	Atmospheric Research, 197, 232-243, 2017. [Impact Factor: 3.377]
96	Nidhi Verma, Aparna Satsangi, Anita Lakhani, K. Maharaj Kumari.	Chemistry	Characteristics of Surface Ozone at a Semi-arid Site in Indo- Gangetic Plain,	Journal of Earth System Science. [Impact Factor:0.858]In press
97	Puneet Kumar Verma, Dinesh Sah, K. Maharaj Kumari, Anita Lakhani	Chemistry	. Atmospheric Concentrations and Gas-particle Partitioning of Polycyclic Aromatic Hydrocarbons (PAHs) and Nitro PAHs at Indo Gangetic Sites.	Environmental Science: Processes and Impacts, DOI: 10.1039/C7EM00168A, 2017. [Impact Factor: 2.54]
98	Dinesh Sah, Puneet Kumar Verma, K. Maharaj Kumari, Anita Lakhani	Chemistry	Fractionation of Airborne Fine Particulate-Bound Metals and Associated Health Risks in A Site in Indo-Gangetic Plain,	International Journal of Engineering Technology Science and Research, 4, 49-55, 2017

99	Ashi Ikram, Sonal Sahai, Snigdha Rai, Sahab Dass, Rohit Shrivastav and Vibha R. Satsangi	Chemistry	Improved Charge Transportation at PbS QDs/TiO ₂ Interface for Efficient PEC Hydrogen Generation	Physical Chemistry Chemical Physics, 18, 15815-15821, 2016. [Impact Factor: 4.12] Cited by 1
100	Nidhi Verma, Aparna Satsangi, Anita Lakhani, K.Maharaj Kumari	Chemistry	Low molecular weight monocarboxylic acids in PM _{2.5} and PM ₁₀ :Quantification , seasonal variation and source apportionment	Aerosol and Air Quality Research, DOI: 10.4209/aaqr.2016.05.0183, 2016. [Impact Factor: 2.27] Cited by 2
101	Awni Agarwal, Nidhi Verma, Rajneesh Kumar Meena, Aparna Satsangi, Anita Lakhani, K. Maharaj Kumari.	Chemistry	Seasonal and Annual Trends in PM _{2.5} and PM ₁₀ Mass Concentrations and Air Quality Index of Agra: A Five Year Study	Journal of Chemical, Biological and Physical Sciences, 6, 1267- 1282, 2016. [Impact Factor: 1.31]
102	Dipika Sharma, Sumant Upadhyay, Vibha R. Satsangi, Rohit Shrivastav, Umesh V. Waghmare, Sahab Dass	Chemistry	Nanostructured BaTiO ₃ /Cu ₂ O heterojunction with improved photoelectrochemica l activity for H ₂ evolution: Experimental and first-principles analysis	Applied Catalysis B: Environmental, 189, 75–85, 2016. [Impact Factor: 8.32] Cited by 6
103	Anuradha Verma, Anupam Srivastav, Anamika Banerjee, Dipika Sharma, Shailja Sharma, Udai Bhan Singh, Vibha Rani Satsangi, Rohit Shrivastav, Devesh Kumar Avasthi, Sahab Dass	Chemistry	A study on the effect of low energy ion beam irradiation on Au/TiO ₂ system for its application in photoelectrochemica l splitting of water	Nuclear Instruments and Methods in Physics Research Section B Beam Interactions with Materials and Atoms, DOI: 10.1016/j.nimb.2016.04.006, 2016. [Impact Factor: 1.38] Cited by 2

104	Anuradha Verma, Anupam Srivastav, Anamika Banerjee, Dipika Sharma, Shailja Sharma, Udai Bhan Singh, Vibha Rani Satsangi, Rohit Shrivastav, Devesh Kumar Avasthi, Sahab Dass	Chemistry	Plasmonic Layer Enhanced Photoelectrochemical Response of Fe ₂ O ₃ Photoanodes	Journal of Power Sources, 315, 152-160, 2016. [Impact Factor: 6.2] Cited by 5
105	Sudhir Kumar Verma and Rambharose	Chemistry	A Review: Cane Sugar Colour and Colourants	Indian Journal of Basic and Applied Research, 1, 55-61, 2016.
106	Shilpa Varshney, Priyanka Jain and Shalini Srivastava	Chemistry	Designing and Potential Use of Tailored Wood Pulp to Remove Heavy Metals from Aqueous System: Kinetic and Thermodynamic Studies.	Separation Science and Technology, 2016. DOI: 10.1080/01496395.2016.1165247. [Impact Factor: 1.2] Cited by 3
	Pushpa Sahni,	Chemistry	Tubulin Conformation and Anaesthetic Interaction - An Experimental Study	Biochemistry & Analytical Biochemistry, 2016. [Impact Factor: 2.22]
107	Priyanka Jain, Shilpa Varshney and Shalini Srivastava	Chemistry	Functionalized Nanobiomaterials: High-Performance Sorbents for Chromium Remediation from Water Streams.	International Journal of Environmental Science and Technology, 13(12), 2893-2904, 2016, DOI: 10.1007/s13762-016-1115-z. [Impact Factor: 2.3] Cited by 1
108	Priyanka Jain, Shilpa Varshney and Shalini Srivastava	Chemistry	Synthetically modified Nano-cellulose for the Removal of Chromium: A Green Nanotech Perspective	International Engineering and Technology: Nanobiotechnology, 2016. doi: 10.1049/iet-nbt.2016.0036. [Impact Factor: 1.5].
109	Priyanka Jain, Shilpa Varshney and Shalini Srivastava	Chemistry	Role of Nanotechnology and Functionalization in the Remediation of Toxic Metals from	International Journal of Latest Technology in Engineering, Management & Applied Science, 5(7), 2016, ISSN 2278-2540. [Impact Factor: 3.5].

			Water System: Environmental Sustainability and Development.	
110	Shilpa Varshney, Priyanka Jain, Jyoti Kumar Arora and Shalini Srivastava	Chemistry	Process Development for the Removal of Toxic Metals by Functionalized Wood Pulp: Kinetic, Thermodynamic and Computational Modeling Approach	Clean Technologies & Environmental Policies, 18, 2613-2623, 2016. [Impact Factor: 1.9]. Cited by 2
111	Shilpa Varshney, Priyanka Jain and Shalini Srivastava	Chemistry	Application of Ameliorated Wood Pulp to Recover Cd(II), Pb(II) and Ni(II) from E-waste	Journal of Material Cycle and Waste Management, DOI:10.1007/s10163-016-0539-3, 2016. [Impact Factor: 1.4] Cited by 2
112	Shilpa Varshney, Priyanka Jain and Shalini Srivastava	Chemistry	Removal of Chromium from E-waste with Functionalized Wood Pulp.	National Academy of Science Letters, 2016. [Accepted for publication] [Impact Factor: 0.35] In press
113	Ram Bharose and S. K. Verma.	Chemistry	A Review: Cane Sugar Colour and Colourants	The Indian Journal of Basic and Applied Research, 1 (1), 55-61, 2016.
114	Mamta, J.N. Srivastava, G.P. Satsangi and Ranjit Kumar	Chemistry	Biogenic constituents of respirable aerosol over semiarid region.	Journal of Chemical Biological and Physical Sciences, 6 (4), 123-132, 2016. [Impact Factor: 1.3]
115	Anupam Srivastav, Anuradha Verma, Anamika Banerjee, Saif A. Khan, Mukul Gupta, Vibha Rani Satsangi, Rohit Shrivastav, Sahab Dass	Chemistry	Gradient doping – a case study with Ti-Fe ₂ O ₃ towards an improve photoelectrochemical response	Physical Chemistry and Chemical Physics, 18, 32735, 2016. [Impact Factor:4.449] Cited by 3
116	Pushpa Sahni,	Chemistry	Tubulin Conformation and Anaesthetic Interaction - An Experimental Study	Biochemistry & Analytical Biochemistry, 5:1, 1-7, 2016. [Impact Factor: 2.22]
117	Sudhir Kumar Verma and Rambharose	Chemistry	A Review: Cane Sugar Colour and Colourants	Indian Journal of Basic and Applied Research, 1 (1), 55-61, 2016.

118	Sonal Sahai, Ashi Ikram, Snigdha Rai, Sahab Dass, Rohit Shrivastav and Vibha R. Satsangi	Physics and Computer Science	“Quantum dots sensitization for photoelectrochemical generation of hydrogen: A review	Renewable Energy and Sustainable Energy Reviews, 68, 19–27, 2017. (IF=6.798)
119	Snigdha Rai, Ashi Ikram, Sonal Sahai, Sahab Dass, Rohit Shrivastav and Vibha R. Satsangi		CNT based photoelectrodes for PEC generation of hydrogen : A Review	International Journal of Hydrogen Energy, 42 (7), 3994-4006, 2017. (IF- 3.4)
120	Anamika Banerjee, Biswajit Mondal, Anuradha Verma, Vibha R. Satsangi, Rohit Shrivastav, Abhishek Dey, Sahab Dass	Physics and Computer Science	Enhancing Efficiency of Fe ₂ O ₃ for Robust and Proficient Solar Water Splitting by Using Highly Dispersed Bioinspired Catalyst	Journal of Catalysis, 352, 83-92, 2017. (IF=7.354)
121	Anuradha Verma, Anupam Srivastav, Saif A. Khan, Vibha Rani Satsangi, Rohit Shrivastav, Devesh Kumar Avasthi, Sahab Dass	Physics and Computer Science	Enhanced Photoelectrochemical Response of Plasmonic Au Embedded BiVO ₄ /Fe ₂ O ₃ Heterojunction	Physical Chemistry and Chemical Physics, 19, 15039, 2017. (IF=4.449)
122	Dipika Sharma, Biswarup Satpati, Vibha R. Satsangi, Rohit Shrivastav, Umesh V. Waghmare and Sahab Dass,	Physics and Computer Science	Electronic Band-offsets across Cu ₂ O/BaZrO ₃ Heterojunction and its Stable PhotoElectro-Chemical Response: First-principles Theoretical Analysis and Experimental Optimization	Renewable Energy, 113, 503-511, 2017. (IF=3.404)
123	Prem Pyari Tiwary, Swati Sharma, Ram Kishor Singh,	Physics and Computer Science	Turbulent amplification of magnetic field in laser plasma	Physics Of Plasmas, 24, 062312 (2017) (Impact Factor:2.12)

	Anju Kumari, Vibha R. Satsangi, and R. P. Sharma		interaction and astrophysical plasmas	
124	Sonal Sahai, Ashi Ikram, Snigdha Rai, Sahab Dass, Rohit Shrivastav and Vibha R. Satsangi	Physics and Computer Science	Augmented Photoelectrochemica l Response of CdS/ZnS Quantum Dots Sensitized Hematite Photoelectrode	International Journal of Energy Research, 40: 1811–1819, 2016 (Impact Factor- 2.5)
125	Ashi Ikram, Sonal Sahai, Snigdha Rai, Sahab Dass, Rohit Shrivastav and Vibha R. Satsangi	Physics and Computer Science	Improved charge transportation at PbS QDs/TiO ₂ interface for efficient PEC hydrogen generation,	Physical Chemistry Chemical Physics, 18, 15815-15821, 2016. (Impact Factor- 4.4)
126	Saatviki Gupta, Thomas J. Whittles, Yogita Batra, Vibha Satsangi, Satheesh Krishnamurthy, Vinod R. Dhanak, Bodh Raj Mehta	Physics and Computer Science	A low-cost, sulfurization free approach to control optical and electronic properties of Cu ₂ ZnSnS ₄ via precursor variation	Solar Energy Materials and Solar Cells, Vol. 157, Pages 820–830, 2016 (Impact Factor- 4.7)
127	Dipika Sharma, Vibha R. Satsangi, Rohit Shrivastav, Umesh V. Waghmare, Sahab Dass	Physics and Computer Science	Understanding the photoelectrochemica l properties of nanostructured CeO ₂ /Cu ₂ O heterojunction photoanode for efficient photoelectrochemica l water splitting,	International Journal of Hydrogen Energy, Volume 41, Issue 41, Pages 18339–18350, 2016 (Impact Factor- 3.4)
128	Dipika Sharma, Vibha R. Satsangi, Sahab Dass, Rohit Shrivastav, Umesh V. Waghmare	Physics and Computer Science	Electronic band- offsets across BaTiO ₃ /Cu ₂ O heterojunction and its stable photo- electro-chemical response: First- principles theoretical analysis and experimental optimization, Proc. SPIE 9935	Solar Hydrogen and Nanotechnology XI, 99350U, 2016

129	Anuradha Verma, Anupam Srivastav, Dipika Sharma, Anamika Banerjee, Shailja Sharma, Vibha Rani Satsangi, Rohit Shrivastav, Devesh Kumar Avasthi, Sahab Dass	Physics and Computer Science	A study on the effect of low energy ion beam irradiation on Au/TiO ₂ system for its application in photoelectrochemical splitting of water	Nuclear Instruments and Methods in Physics Research Section B: Beam Interactions with Materials and Atoms, Volume 379, Pages 255–261, 2016(Impact Factor- 1.4)
130	Dipika Sharma, Sumant Upadhyay, Vibha R. Satsangi, Rohit Shrivastav, Umesh V. Waghmare, Sahab Dass	Physics and Computer Science	Nanostructured BaTiO ₃ /Cu ₂ O heterojunction with improved photoelectrochemical activity for H ₂ evolution: Experimental and first-principles analysis	Applied Catalysis B: Environmental, Volume 189, Pages 75–85, 2016 (Impact Factor- 8.3)
131	Anuradha Verma, Anupam Srivastav, Anamika Banerjee, Dipika Sharma, Shailja Sharma, Udai Bhan Singh, Vibha Rani Satsangi, Rohit Shrivastav, Devesh Kumar Avasthi, Sahab Dass	Physics and Computer Science	Plasmonic layer enhanced photoelectrochemical response of Fe ₂ O ₃ photoanodes	Journal of Power Sources, Volume 315, Pages 152–160, 2016 (Impact Factor- 6.3)
132	Chaudhry Surbhi Yadav Yamini Satsangi Vibha R Shrivastav, Rohit, Dass, Sahab	Physics and Computer Science	Photoelectrochemical performance of CuO electrodes by surface modification with ZnO in water splitting process	AIP Conference Proceedings, Volume 1728, Issue 1, 2016
133	Dipika Sharma, Sumant Upadhyay, Vibha R. Satsangi, Rohit	Physics and Computer Science	Ni-Doped Cu ₂ O Thin Films for Solar-Hydrogen Generation: Experiments and	Advanced Science Letters, Volume 22, Number 4, pp. 780-784(5), 2016 (Impact Factor- 1.23)

	Shrivastav, Umesh V. Waghmare, Sahab Dass		First-Principles Analysis	
134	Anupam Srivastav, Anuradha Verma, Anamik a Banerjee, Saif A. Khan, Mukul Gupta, Vibha Rani Satsangi, Rohit Shrivastav and Sahab Dass	Physics and Computer Science	Gradient doping – a case study with Ti- Fe ₂ O ₃ towards an improved photoelectrochemica l response	Phys. Chem. Chem. Phys., 2016,18, 32735-32743, 2016 (Impact Factor- 4.4)
135	Deep Prakash C. Patvardhan C. Vasantha Lakshmi	Physics and Computer Science	MAYO index for Deep Analytics of Price and Performa nce of IPL Players	IJCA, (0975-8887), Volume 150, No. 2, September 2016, PP 37- 44
136	C. Deep Prakash C. Patvardhan C. Vasantha Lakshmi	Physics and Computer Science	Data Analytics based Deep Mayo predictor for IPL	IJCA, (0975-8887), Volume 152, No. 6, October 2016, PP 6-11
137	Sukriti Paliwal, C. Vasantha Lakshmi, C. Patvardhan	Physics and Computer Science	Real Time Heart Rate Detection and Heart Rate Variab ility Calculation	IEEE HTC 2016
138	C. Patvardhan, Pragyesh Kumar C. Vasantha Lakshmi	Physics and Computer Science	Effective Color image watermarking scheme using YCbCr Color space and QR code	Multimedia tools and applications, Springer, PP 1-23
139	Sweta Bhan, Lalit Mohan, Chand Narayan Srivastava.	Zoology	Efficacy of Cuscuta reflexa extract and its synergistic activity with Temephos against mosquito larvae .	International Journal of Mosquito Research. 2 (1): 34-41
140	Sweta Bhan, Lalit Mohan, C.N. Srivastava	Zoology	Combinatorial studies on thermosensitization of Nanoencapsulated temephos and Cuscuta reflexa.	International J. Pharmaceutical Res. and Bio Sciences. 4(1): 20- 35
141	Sweta Bhan, Lalit Mohan, C. N. Srivastava.	Zoology	Photosensitization of nanoencapsulated temephos and Cuscuta reflexa combination on mosquito larvae.	International J. Pharmaceutical Res. and Bio Sciences. 4(1): 94- 110

142	Vijay Kishore, C. N. Srivastava, Ashok Kumar, Lalit Mohan.	Zoology	Relative acaricidal bioefficacy of certain root extracts of <i>Adhatoda vasica</i> against <i>Rhipicephalus (Boophilus) microplus</i> (acari: ixodidae).	International Journal of Pharmaceutical Research and Bio-Science. 4(4): 224-235.
143	Vyas Netu, K K Dua and Soam Prakash.	Zoology	Bioactive microbial active metabolites against <i>Culex</i> and <i>Anopheles</i> mosquito larvae.	International Journal of Zoological investigations. Vol 2 (2): 183-188.
144	Neetu Vyas, K K Dua and Soam Prakash.	Zoology	Larvicidal Activity of Metabolites of <i>Metarhizium anisopliae</i> against <i>Aedes</i> and <i>Culex</i> Mosquitoes.	Entomology, Ornithology & Herpetology. 4:4.
145	Richa, D.K. Chaturvedi and Soam Prakash	Zoology	The consciousness in mosquitoes.	Journal of mosquito research. 6 (34): 1-9.
146	Richa, D.K. Chaturvedi and Soam Prakash.	Zoology	Role of electric and magnetic energy emission in intra and interspecies interaction in microbes.	American Journal of Research Communication, Vol 4(12): 1-22.
147	Namita Soni and Soam Prakash.	Zoology	Bio-nanoparticles: an eco-friendly approach for mosquito control and antimicrobial.	The Journal for Nanotechnology: PHOTON 105 (2016) 138-152.
148	Vijay Kishore, C.N. Srivastava, Ashok Kumar, Lalit Mohan.	Zoology	Toxic potentiality of <i>Adhatoda vasica</i> root extracts against <i>Hyalomma anatolicum</i> (Acari: Ixodidae).	Journal of Entomological Research. 40 (2): 149-155.
149	Mahima Verma and Alka Prakash	Zoology	Incidence of Coagulase positive <i>Staphylococcus</i> in raw camel milk from different regions of India: A possible threat to Diabetic Consumers.	Advances in Applied Science Research. 7(4):121-126.
150	Shabad Preet and Shivani Gupta.	Zoology	Genetic Diversity studies on <i>Culex quinquefasciatus</i> from diverse larval habitats using RAPD-PCR marker.	Journal of Mosquito Research. 4(2): 93-98.

151	Priya Agnihotri and Arun P. Sikarwar.	Zoology	Neuroprotective potential of phytomedicines by qualitative and quantitative analysis of antioxidants.	Indian Journal of Basic And Applied Research. 2(2):129-133
152	Rahul Singh Tomar and Shabad Preet.	Zoology	Evaluation of anthelmintic activity of biologically synthesized silver nanoparticles against the gastrointestinal nematode, Haemonchus contortus.	Journal of Helminthology 91(4):454-461.
153	Richi Nagayash, U.D Gupta and Alka Prakash.	Zoology	Expression profiling of hsp 70 gene during different seasons in goats (Capra hircus) under sub-tropical humid climatic conditions.	Small Ruminant Research, 147:41-47.
154	Vijay Kishore, Neha Loach, Ashok Kumar, C.N. Srivastava, Lalit Mohan.	Zoology	Toxicity evaluation of cypermethrin, deltamethrin and diazinon with reference to Hyalomma anatolicum (Acari: Ixodidae)	Journal of Entomological Research. 41 (3): 251-256.
155	Deeksha Gautam, Neha Loach, Sanjeev Kumar Yadav, C. N. Srivastava, Lalit Mohan.	Zoology	Bioefficacy evaluation of certain oleoresins against the larvae of Rhipicephalus microplus (acari: ixodidae).	Advances in BioResearch. 8 (5): 2017

Faculty of Social Science

156	Swami Prakash Srivastava	Economics	Demonetization in India and its Future Impact on Indian Economy	International Journal (SAJOSPS) –ISSN: 0972-4613 Vol. 17 (January- June 2017) PP 5-13
157	Swami Prakash Srivastava	Economics	Role of FDI in Economic Development of India- Issues, Opportunities and Challenges	International Journal “Advance in Economics and Business and Business Management” (AEBM) p- ISSN: 2394-1545: e-ISSN: 2394-1553: Vol:4 ISSUE 2: January- March 2017, pp 126-135

158	Swami Prakash Srivastava	Economics	Role of Women in Indian Agriculture-Issues and Challenges	International Journal – (Journal of Agro ecology and Natural Resource Management) p-ISSN: 2394-0786, e ISSN: 2394-0794, Vol-4, Issue- 1, January-March 2017, pp 37-43
159	Sangeeta Kumar	Economics	Ideas of Swami Vivekananda in Context of Indian Economy	International Journal Of Electronic, Electrical And Computational System (IJEECS), ISSN: 2348-117X, Vol 6, Issue 9, Sep 2017, Pg.498-502, Impact factor 2.52
160	Sangeeta Kumar	Economics	Mr. Narendra Modi and The Indian Economy: Status And Challenges	International Journal Of Engineering Technology Science And Research IJETSAR, Impact Factor 2.120, ISSN: 2394 – 3386, Vol-4, Issue 8, pp 1258-1264, August 2017
161	Sangeeta Kumar	Economics	Role of Technology in Promoting Financial Literacy in Poor: An Effective Way for Financial Inclusion”	Journal of International Academic Research for Multidisciplinary, Impact Factor 3.114, ISSN: 2320-5083, Volume 5, Issue 2, March 2017, pp122-129
162	Jyoti Gogia	Economics	Food-Consciousness -Food Security: Connecting the Dots	Indian Journal of Economics and Development Vol. 5(5), May 2017, ISSN: 2320-9828
163	Jyoti Gogia	Economics	The Employers’ Perspective towards Women Domestic Workers	Indian Journal of Economics and Development Vol. 4 (5), May 2016, ISSN: 2320-9828
164	Rupali Satsangi	Economics	A Conceptual Study on Poverty Alleviation through Sustainable Livelihood	International Journal of Science Technology and Management, Vol. 5(5), ISSN: 2394-1537, pp. 488-494, 2016
165	Rupali Satsangi	Economics	Micro insurance for Vulnerable Section of Society: An Analytical Study	”, International Journal of Engineering, Technology, Science and Research, Vol. 3, Issue 1, ISSN: 2394-3386, pp. 81-94, 2016
166	Resham Chopra	Economics	Perception of Tax Payers towards GST: A Fiscal and Social Psychology model Approach	Indian Accounting Review, June 2017 Issue, Bi-annual refereed international journal, pp 62-79, ISSN: 0972-1754
167	Pathak Shachi, S. Nigam, and S. Swami	Management	Empirical Study on Measuring Service Quality and Customer Purchase Intention of Non-Air travel by E-Ticketing	Journal of Development Research, 8 (4), pp. 15-25.

168	Mathur, Mahima, S. Swami, and S. Bhatnagar	Management	BOP Business Models and Strategy	Amity Journal of Management Research, Volume I, Issue 1, pp. 110-123.
169	Shachi Pathak, Sanjeev Swami, Shalini Nigam	Management	Make in India campaign' for manufacturing sector: A strategic analysis	International Journal of Applied Research; 2(5): 481-486
170	V. Ramani and S. Swami	Management	Demand Expansion and Price Premium Effects of Marketing Effort: Modeling and Comparative Analysis	Economics Bulletin, 37(2), 1234-1246.
171	Mishra,P., Sharma, S.K., Swami, S.	Management	Antecedents and Consequences of organizational politics: a select study of a central university	1. Journal of advances in Management.Emerald.13 (3),334-351
172	Sharma, S.K., Shukla, A.(Management	Impact of Electronic Word on Mouth on Consumer Behaviour and Brand Image	Asian Journal of Management, 8(3)July,2017, pg 501-506, 2017
173	Sharma, S.K., Pathak, K.	Management	Bottom up approach for better implementation of policies using organic façade of strategic human resources: A general perspective	AGU: International Journal of Management Studies and Research, Vol. 7, pg 25-35, 2017
174	Shiv Kumar Sharma	Management	Golden Bird': A Gap Analysis of Governments Initiatives and Tourist Expectations in Uttar Pradesh using Systems Approach	69th All India Commerce Conference of Indian Commerce Association, 11-13 November 2016 at Lucknow University.
175	Sanjay Bhushan, Sanjeev Swami, Shiv Kumar Sharma, Anand Mohan	Management	(A) Augmenting (A) Action for (D) Disaster Management through (I) Indigenous Knowledge (Gyan): A.A.D.I. GYAN - CONSCIOUSNESS: A Digital Library Initiative	TSC-2016 East West Forum Conference, Arizona, USA. 2016

176	Ishika Agarwal, Shalini Nigam, Sanjeev Swami	Management	Stepping Towards Conscious Marketing: A Case Based Approach	TSC-2016 East West Forum Conference, Arizona, USA, 2016
177	Sanjeev Bhatnagar	Management	A Study on Issues and Challenges of Women Empowerment in India	International Journal of Business and Administration Research Review, Bangalore, Oct-Dec 2016 volume-1, Issue No-16, Impact Factor 3.853 page no.1-7.
178	Sanjay Bhushan	Management	System Dynamics Base-Model of Humanitarian Supply Chain (HSCM) in Disaster Prone Eco-Communities of India: A Discussion on Simulation and Scenario Results	IJSDA, Volume 6, Issue 3, Article 2, July, 2017. (Clarivate (formerly Thomson Reuters) Web of Science index, the <u>Emerging Sources Citation Index-ESCI</u>)
180	Sanjay Bhushan	Management	Global Challenges and Value-based Quality Education For Holistic Development in Higher learning Institutions	6th Higher Education in the World report "Towards a Socially Responsible University: Balancing the Global and the Local", World GUNi Report 2017
181	Sanjay Bhushan	Management	System dynamics Modeling-based analysis of combating counterfeit drugs supply chain in India	International Journal of Emergency Management, Inderscience Publishers, Volume 13, Issue 1, pp.19-49, January, 2017.
182	Singh, Sanjeev Kumar and Satsangi, A.K.	Management	Promotional Practices In Life Insurance Sector: A Study Of Indian Consumer Perspective. Chronicle of Humanities And Cultural Studies.	Vol.3 No.4, Aug.; 2017, 42-50. (ISSN: 2454-5503.)
183	Faize Ali Shah and Satsangi A.K. Frugal	Management	Innovation In Healthcare Industry: A Case Study Of Asopa Hospital	International Journal Of Engineering Science And Management Eissn:2454-4140
184	A.K. Satsangi	Management	A Study on Emotional Intelligence and Entrepreneurial Self-Efficacy among Management Students in India	International Journal of Informative & Futuristic Research, vol 4, Issue 7 (September 2017)

185	Shweta Khemani and Sumita Srivastava	Management	Determinants of Employee Spirituality and their Outcomes: a Study of Banking Sector at Agra Region	International Journal of Research in Commerce and Management, ISSN (Print): 0976-2183, Volume 7 Issue 5 (2016), pp: 68-73
186	Sumita Srivastava and Rupali Misra Nigam	Management	Exploring Antecedents of Entrepreneurial Intentions of Young Women in India – A Multi-method Analysis	Journal of Entrepreneurship in Emerging Economies, ISSN: 2053-4604, Vol. 9 No. 2, 2017, pp: 181-206
187	Kanika, Sumita Srivastava and Nandita Satsangee,	Management	Comparison of Enablers of Entrepreneurship and Managerial Success in the Context of Current Business Environment in India: A Pilot Study	International Conference on Make in India-Campaign for Inclusive Growth: Initiatives and Challenges, organized by Dept. of Commerce, Aligarh Muslim University, Aligarh, India during January 4-5, 2016.
188	Shweta Khemani and Sumita Srivastava	Management	Creativity and Initiative Driven by Value Orientation: A Stepping Stone towards the Success of Make in India Campaign	International Conference on Make in India-Campaign for Inclusive Growth: Initiatives and Challenges, organized by Dept. of Commerce, Aligarh Muslim University, Aligarh, India during January 4-5, 2016.
189	Sumita Srivastava, Kanika and Nandita Satsangee	Management	What Affects Entrepreneurial Intentions of Young Women in India?: Current Status and the Way Forward	International Conference on 'Entrepreneurship and Women Empowerment' organized by The National Institute for Entrepreneurship and Small Business Development (NIESBUD), Ministry of Skill Development and Entrepreneurship, Govt. of India on 18-19 November 2016. (ISBN: 978-81-932181-6-7)
190	Sumita Srivastava and Anjul Dayal	Management	Impact of Surat Shabda Yoga on Organizational Behaviour of Employees: A Multi Method Analysis	Centre for Consciousness Studies, University of Arizona, at San Diego, USA during June 5-10,2017
191	Sunita Malhotra	Management	Role of Skill Development Programs in Achieving Inclusive Growth of Indian Economy	International Conference on "Make in India - Campaign for Inclusive Growth; Initiatives and Challenges" held at Aligarh Muslim University on January 4th and 5th, 2016.

192	Banger, A.K., & Sharma, S.K.	Management	Empirical Evidences of Value Creation from Banking Industry of India	<i>Global Journal of Enterprise Information System, Vol8(3), pp,45-51, 2016.</i>
193	Gangal, V.K. Agrawal, A., Banger, Kr. A	Management	Liberalisation and Current Account Balance: An Empirical Evaluation	<i>Global Journal of Enterprise Information System, Vol9(2)pp10-15,2017.</i>
194	Pandey Abhinav	Management	Cloud Computing Implementation: An Analysis using Systems Approach	International Journal of Distributed and Cloud Computing, Volume 2, Issue 4, 2016; (ISSN: 2321-6840)
195	Nayyar Tanya, Pandey Abhinav	Management	An Analytical Study of Search Engine Optimization (SEO) Techniques: To Maximize Number Of Visitors On An E-Content Website	The International Journal of Technology and Science, Volume VIII, Issue 3,2016;(ISSN: 23501111)
196	Bhatnagar, Purnima, Nigam, Shalini, Prashant, Prem & Caprihan, Rahul	Management	Desirable Traits of a Conscious Leader: An Empirical Survey	The Delhi University Journal of the Humanities and Social Sciences, Vol 3, pp. 71-91, 2016
197	Purnima Bhatnagar, Shalini Nigam and Y. Suresh Reddy	Management	Innovative Educational Corporate Social Responsibility Initiatives for Inclusive Growth in India – Challenges and Lessons Learnt	Journal of Innovation for Inclusive Development, Vol 1, No. 1, pp 26-32, 2016
198	Kaur, J., Chopra, R., Nathani, N.	Management	Perception of Tax Payers Towards GST: A Fiscal and Social Psychology Model Approach	Indian Accounting Review, 21(1), 62-79.
199	Nathani, N., Kaur, J., Khator, D.	Management	Artificial Neural Network: Validity of Technical Analysis for predicting stock prices	GITAM Journal of Management, 15(2), 52-67.
200	Jaspreet Kaur	Management	Developing an early warning signal: Financial Stability Index	Global Trends in Business & Sustainability Research, held on December 2-4, 2016, held at IIT Rourkee. 3333333
201	Jaspreet Kaur	Management	Perception of tax Payers' Towards GST: A Fiscal and Social Psychology Model Approach	39th All India Accounting Conference & International Seminar on Accounting Education and Research, held on December 16-17, 2016, held at

				Central College Campus, Bangalore University, Bangalore.
202	Anand. H. & Das, I.	Psychology	Effect of Prayer along with Meditation v/s Meditation on Emotional Intelligence and Psychological Well Being: A Comparative Study	The International Journal of Indian Psychology, 3(4),187-202,ISSN: 2348-5396(e),2349-5159 9
203	Kumar. S. & Satsangi, A.	Psychology	Comparative Study of Selective Attention: Yogic and Modern Education System	International Journal of Yoga and Allied Science, 5(2),113-119 ISSN No. 2278-5159 9
204	Satsangi, A. & Begum, A.	Psychology	Does Intelligence influence Social Maturity in Academic Life ?	Indian Journal of Positive Psychology, pp: 302-305, Vol.-VII, Issue-3, ISSN 2229-4937
205	Dutt, S. & Kumari, P.	Psychology	Effect of Socio-Economic Status and Academic Achievement towards Environmental Consciousness	International Journal of Multidisciplinary Research and Modern Education, 2(2), 2016
206	Dutt, S. & Kumari, P.	Psychology	Personality Traits as Predictors of Students' Well Being and Life Satisfaction	Indian Journal of Health and Well-Being, 7(6), 2016
207	Dutt, S. & Kumari, P.	Psychology	Effect of Environmental Educational on the Attitude of College Students	International Journal of Indian Psychology, 3(4),2016
208	Raundeley, S. & Kumari, P.	Psychology	Consciousness, Locus of Control & Religiosity Among Adolescents	International Journal of Applied Research, 2(9), 517-521, ISSN Print 2394-7500,ISSN Online: 2394-5869, 2016
209	Raundeley, S. & Kumari, P.	Psychology	Consciousness, Religiosity & Locus of Control as Predictors of Well-Being Among Young Adolescents	The International Journal of Indian Psychology,4(1), 86-92, ISSN Online: 2348-5396, ISSN Print: 2349-3429, ISBN: 978-1-365-51571-2
210	Yukti Goel and Kamaljeet Sandhu	Psychology	Construction of Metacognitive Thinking Scale(MTS)	I257-264, 2016RA International Journal of Education and Multidisciplinary Studies, ISSN 2455-2526, Vol. 03(02)

211	Sharma, U. & Satsangi, A.	Psychology	A Theoretical Approach: Knowledge Management as Intervention of Stress	International Journal of Applied Research, 2(8), 42-46, 2016
212	Kumari, P. & Chaturvedi, S.	Psychology	Relationship of Multidimensional Perceived Social Support with Adolescents' Depression	International Journal of Multidisciplinary Research and Modern Education ,2(1), 120-124,2016
213	Kumari, P. & Chaturvedi, S.	Psychology	Contribution fo Positivve Emotion Regulation Strategies in Depression	International Journal of Applied Research,2(8), 444-446, 2016
214	Singh, H. & Negi, S. K.	Psychology	Gender Equality and Women Empowerment: A Qualitative Study on Kinnauri Tribal Women in Social Work Prospective	IA- International Journal of Management & Social Sciences, 3, 163-181, 2016
215	Singh, H. & Negi, S. K.	Psychology	Psychological Analysis of Hydro Project Affected Tribal People	DCRD Publications, Cochin, 108-119, 2016
216	Anand, H.	Psychology	Book Review: Yoga Psychotherapy and its applications	International Journal of Adapted Physical Education & Yoga, 2(8), 16-18, ISSN No. 2455-8958
217	Satsangi, A. & Kumar, S.	Psychology	Does Education System Effect Personality?	Indian Psychological Review, 88(3), 129-136, ISSN No. 0019-6215
218	Kamaljeet Sandhu and Rashmi	Psychology	Emotional Intelligence and Motivation as Determiners of Administrative Behavior in Educational Institution	International Journal of Applied Business and Economic Research Volume: No. 15, Issue No. : 1, pp 349-361, ISSN: 09727302, 2017
219	Begum, A. & Satsangi, A.	Psychology	Emotional Maturity: Intelligence and Academic Streams	Asian Resonance : A Peer Reviewed Multidisciplinary International Research Journal, 6(3), 2017 pp-164-169
220	Sharma, U. & Satsangi, A.	Psychology	Contribution of Spirituality and Attachment in Life Satisfaction	The International Journal of Indian Psychology, 5-11, 2011

221	Kumari, P. & Chaturvedi, S.	Psychology	Gender Differences Using Positive Reappraisal in Depression	International Journal of Humanities and Social Science Research, 3(2), 1-2, 2017
222	Chaudhary, S. & Das, I.	Psychology	Spiritual Behavior as strongest Life Style Predictor of Life Satisfaction With Special Reerence to Type II Diabetes	International Journal of Humanities and Social Sciences Research, 3(1), 27-34, 2017
223	Priyanka Singh	Sociology & Political Science	Child Exploitation:A Bane Against Humanity with Reference to Varanasi City	International Journal of Sociological Research, Vol.8 No.1 2016
224	Deepika Chauhan	Sociology & Political Science	A scientific study of genotoxic-carcinogenic impacts of Potassium bromate as food additive on human health,	International Research Journal of Engineering & Technology, VOL.3, Issue 8, 2016 Women Trafficking: A Blot on Human Rights in Society, International Journal of Advanced Research(IJAR) June 30 Issue, VOL4, 2016
225	Deepika Chauhan	Sociology & Political Science	Emergence of Worker's Movements in Contemporary India: Rooted in Socio-historic analysis of Peasant Consciousness	International Educational and Research Journal, July 2016
226	Deepika Chauhan	Sociology & Political Science	Impact of Climate change on agrarian productivity in relation with socio-economic sustainability in India	International Educational and Research Journal (IERJ), July 2016
227	Deepika Chauhan	Sociology & Political Science	“TRIBAL-IDENTITY & SOCIAL EXCLUSION: Challenges & Prospects” (With special reference to the tribes of Central India	Research Paper in International Journal , 2016
228	Poornima Jain & Reena	Sociology & Political Science	Naxalbari Andolan ke samajikevam arthik Prabhav	Shoadh Dristhi, ISSN No.0975-0711

229	Ishwar S. Sahai	Sociology & Political Science	Challenges of the Excluded Community in Panchayats: A Study Based on Mirzapur Distt. In Uttar Pradesh	Research Highlights: A Multidisciplinary Quarterly International Referred Journal ISSN: 2350-0611, pp-197-207
230	Birpal S. Thenuan	Sociology & Political Science	Khap Panchayats Among the Jats of North-West: A Socio-Historical Interpretation of Medieval Period	IRA, International Journal of Management & Social Sciences, Vol. 5 No. 3 pp- 402-407, Dec. 2016, ISSN No. 2455-2267
231	Birpal S. Thenuan	Sociology & Political Science	Khap Panchayats and Their Resolution of 1950: A Sociological Interpretation, Remarking: An Analisation	Multi-Disciplinary International Journal, Vol. 1 Issue 10, pp 101-104, Jan. 2017, ISSN No. (E) 2455-0817, ISSN No. (P) 2394-0344
232	Birpal S. Thenuan	Sociology & Political Science	A Sociological Study of Health Consciousness Among the Senior Citizens	International Journal of Education & Multidisciplinary Studies, Vol. 6. Issue 03, pp-231-240, March 2017 ISSN No.2455-2526
233	Birpal S. Thenuan	Sociology & Political Science	Samajik Anusandhan Mein SHodhpatra Lekhan Vigyan Ya Kala	Innovation: The Research Concept, Multi-Disciplinary Bi-Lingual International Journal, Vol.II, Issue III, pp 40, April 2017, ISSN (P) 2456-5474
234	Birpal S. Thenuan	Sociology & Political Science	Notbandi Ka Kisano Tatkalik Prabhav: Uttar Pradesh Ke Agra Janpad Ke Aalu Utpaadak Kisano Ka Ek Samaj Shastriya Adhayayan	Anthology The Research, pp 9-13, Vol. II, Issue II May 2017, ISSN 2456-4397
235	Lajwant Singh	Sociology & Political Science	Opportunity of Employment Among Rural Labour Women Through Mahatma Gandhi Nationall Rural Employment Guarantee Act (MNREGA)- A Case Study from Meerut District of Western U.P. pp. 5561-5574	International Journal of Informative & Futuristic Research, (IJIFR) Pioneering Journals Publishers Model Town Ambala City, Haryana, ISSN No. 2347-1697, Vol. 4 , Issue 3
236	Lajwant Singh	Sociology & Political Science	Impact of Globalization on the Development of	International Peer Reviewed Journal of Current Research and Modern Education, Tamilnadu ,

			Weaker Section (A Study from Slums of Ghaziabad) city of U.P	India, ISO 9001-2015, ISSN No. 2455-5428
237	Lajwant Singh	Sociology & Political Science	Yug Purush Dr. Bhimrao Ambedkar Evam Dalit Samajik Parivartan: Ek Vishleshnatmak Adhyayan	Multidisciplinary International Research Journal, Dixit Poddar Foundation, Varanasi, ISSN No. 0974-7648 , Vol 9
238	Lajwant Singh	Sociology & Political Science	Poverty Status in India: An Analytical Study	IPRA:Nagpur, ISSN No. 0975-0568, Vol. 10 Issue 1
239	Lajwant Singh	Sociology & Political Science	Empowerment of Rural Women of Meerut	IPRA, Nagpur ISSN No. 0975-0568, Vol. 11 Issue 1

**ANNEXURE FOR DEI STUDY CENTRES AND
DEI ICT DISTANC EDUCATION CENTRES**

PROGRAMME OFFERED BY ICT Centers during 2016-17

S. No.	ICT CENTRE	PROGRAMME
1	MTV Puram	Diploma Electrical Engineering
2	Amritsar	Diploma Electrical Engineering
3	Timarni	Class XI
		Class XII
		Diploma 1st Year*
		Diploma 2nd Year*
		Diploma 3rd Year*
4	Soami Nagar, New Delhi	MBA Semester I
		MBA Semester III
		B.Ed.
		M. Phil (Theology)
5	Murar	Diploma Electrical Engineering

DEI DISTANCE EDUCATION CENTRES

S. No.	CENTRE	PROGRAMME
1	AMALAPURAM	<ul style="list-style-type: none"> • Cutting & Sewing
2	HANAMKONDA	<ul style="list-style-type: none"> • Cutting & Sewing (Modular Course)
3	KADAPA	<ul style="list-style-type: none"> • Office Assistant –Cum-Computer Operator, • Cutting & Sewing, • Wireman
4	KAKINADA	<ul style="list-style-type: none"> • Modern Office Management & Secretarial Practice, • Dress Designing & Tailoring, • Motor Vehicle Mechanic (4 Wheeler)
5	KURNOOL	<ul style="list-style-type: none"> • Dress Designing & Tailoring, • Motor Vehicle Mechanic (4 Wheeler)
6	MOOSAPET	-
7	PRODDATUR	<ul style="list-style-type: none"> • Dress Designing & Tailoring, • Wireman, • Motor Vehicle Mechanic (4 Wheeler), • Office Assistant –Cum-Computer Operator, • Textile Designing & Printing, • BBM (Hons)
8	RAJAHMUNDRY	<ul style="list-style-type: none"> • Block Printing and other Modular Courses in Textiles
9	SECUNDERABAD	<ul style="list-style-type: none"> • Cutting & Sewing / Dress Designing & Tailoring, • Motor Vehicle Mechanic (4 Wheeler), • MBA, • PGDT
10	SRIKAKULAM	<ul style="list-style-type: none"> • Dress Designing & Tailoring, • Office Assistant –Cum-Computer Operator
11	VIJAYWADA	<ul style="list-style-type: none"> • Cutting & Sewing

12	VISAKHAPATNAM (CITY)	<ul style="list-style-type: none"> • Modern Office Management & Secretarial Practice
13	VISAKHAPATNAM (DAYAL NAGAR)	<ul style="list-style-type: none"> • Office Assistant –Cum-Computer Operator, • Modern Office Management & Secretarial Practice • Electrician, • Textile Designing & Printing, • Cutting & Sewing, • Dress Designing & Tailoring, • Motor Vehicle Mechanic (4 Wheeler), • PGDT, • MBA, • Block Printing (Modular Course)
14	VIZIANAGARAM	<ul style="list-style-type: none"> • Dress Designing & Tailoring, • Motor Vehicle Mechanic (4 Wheeler), • Electrician
15	GAYA	<ul style="list-style-type: none"> • Dress Designing & Tailoring, • Electrician, • PGDT
16	MURAR	<ul style="list-style-type: none"> • Dress Designing & Tailoring/Cutting & Sewing, • Wireman, • Electrician, • Motor Vehicle Mechanic (4 Wheeler), • Welding – Modular Course, • Textile Technology, • Industrial Painting (Modular Course)
17	PATNA	<ul style="list-style-type: none"> • Wireman, • Dress Designing & Tailoring, • Office Assistant –Cum-Computer Operator
18	JANAK PURI NEW DELHI	<ul style="list-style-type: none"> • Office Assistant –Cum-Computer Operator, • PGDT • Dress Designing & Tailoring, • Basic Electronics and Repair of Inverter, UPS and Stabilizer (Modular Course)
19	KAROL BAGH, DELHI	<ul style="list-style-type: none"> • Dress Designing & Tailoring, • Office Assistant –Cum-Computer Operator, • PGDT, • BBM (Hons), • Electrician, • MBA, • PGDJMC
20	SHAHDARA DELHI	<ul style="list-style-type: none"> • Dress Designing & Tailoring, • PGDT
21	SOAMI NAGAR -NEW DELHI	<ul style="list-style-type: none"> • Office Assistant –Cum-Computer Operator, • Electrician, • Textile Designing & Printing, • PGDT, • B.Com (Hons), • MBA

22	MEHSANA	<ul style="list-style-type: none"> • Dress Designing & Tailoring, • Wireman, • Motor Vehicle Mechanic (4 Wheeler)
23	SURAT	<ul style="list-style-type: none"> • Wireman • Textile Designing & Printing
24	VADODARA	<ul style="list-style-type: none"> • Wireman, • Motor Vehicle Mechanic (4 Wheeler)
25	AMBALA	<ul style="list-style-type: none"> • Office Assistant cum Computer Operator
26	FARIDABAD	<ul style="list-style-type: none"> • Office Assistant cum Computer Operator (Dual), • Electrician, • Textile Designing & Printing, • Dress Designing & Tailoring, • PGDT
27	GURGAON	<ul style="list-style-type: none"> • Cutting & Sewing /Dress Designing & Tailoring, • Office Assistant –Cum-Computer Operator, • BBM (Hons), • MBA, • PGDT
28	KARNAL	<ul style="list-style-type: none"> • Cutting & Sewing /Dress Designing & Tailoring • Modular Courses in Textiles
29	PANCHKULA	<ul style="list-style-type: none"> • Motor Vehicle Mechanic (4 Wheeler), • Wireman, • Office Assistant –Cum-Computer Operator
30	YAMUNA NAGAR	<ul style="list-style-type: none"> • Cutting & Sewing
31	AMB (UNA)	<ul style="list-style-type: none"> • Modern Office Management & Secretarial Practice
32	DHARAMSHALA	<ul style="list-style-type: none"> • Modern Office Management & Secretarial Practice, • Dress Designing & Tailoring
33	SHIMLA	<ul style="list-style-type: none"> • Dress Designing & Tailoring
34	JAMMU	<ul style="list-style-type: none"> • Modern Office Management & Secretarial Practice • Cutting & Sewing/ Dress Designing & Tailoring, • Electrician
35	DEOGHAR	<ul style="list-style-type: none"> • Office Assistant Cum – Computer Operator, • Dress Designing & Tailoring
36	DHANBAD	<ul style="list-style-type: none"> • Office Assistant –Cum-Computer Operator
37	JAMSHEDPUR	<ul style="list-style-type: none"> • Cutting & Sewing, • Motor Vehicle Mechanic (4 Wheeler), • Office Assistant –Cum-Computer Operator, • Electrician, • MBA
38	RANCHI	<ul style="list-style-type: none"> • Electrician • Motor Vehicle Mechanic (4 Wheeler)
39	BANGALORE	<ul style="list-style-type: none"> • Dress Designing & Tailoring, • MBA, • Electrician
40	BHOPAL	<ul style="list-style-type: none"> • Cutting & Sewing (Modular) • Textile Designing & Printing, • Modern Office Management & Secretarial Practice • Bamboo Technology

41	GWALIOR	<ul style="list-style-type: none"> • Cutting & Sewing, • Wireman, • Modern Office Management & Secretarial Practice • Bamboo Technology
42	INDORE	<ul style="list-style-type: none"> • Dress Designing & Tailoring, • Cutting & Sewing, • Office Assistant –Cum-Computer Operator, • Bamboo Technology
43	JABALPUR	<ul style="list-style-type: none"> • Dress Designing & Tailoring, • Bamboo Technology
44	RAJABORARI	<ul style="list-style-type: none"> • Cutting & Sewing, • Office Assistant –Cum-Computer Operator, • B.Com (Hons) • Bamboo Technology
45	TIMARNI	<ul style="list-style-type: none"> • Motor Vehicle Mechanic (4 Wheeler), • Wireman, • Dress Designing & Tailoring, • Bamboo Technology
46	MUMBAI	<ul style="list-style-type: none"> • DD&T (Modular), • Office Assistant –Cum-Computer Operator, • BBM, • MBA, • PGDCSA
47	NAGPUR	<ul style="list-style-type: none"> • Wireman, • Dress Designing & Tailoring, • Office Assistant –Cum-Computer Operator
48	NANDURBAR	
49	PANVEL	<ul style="list-style-type: none"> • Dress Designing & Tailoring, • Automobile (Community College, DEI)
50	PUNE	<ul style="list-style-type: none"> • BBM (Hons), • PGDT, • MBA, • Electrician
51	ROURKELA	<ul style="list-style-type: none"> • Dress Designing & Tailoring
52	AMRITSAR	<ul style="list-style-type: none"> • Dress Designing & Tailoring, • BBM (Hons), • MBA
53	BATALA	<ul style="list-style-type: none"> • Dress Designing & Tailoring
54	BATHINDA	<ul style="list-style-type: none"> • Wireman, • Dress Designing & Tailoring
55	DAYALPUR	<ul style="list-style-type: none"> • Electrician
56	JALANDHAR	<ul style="list-style-type: none"> • Dress Designing & Tailoring, • Electrician
57	LUDHIANA	<ul style="list-style-type: none"> • Modern Office Management & Secretarial Practice • Motor Vehicle Mechanic (4 Wheeler), • Dress Designing & Tailoring, • PGDT, • B.Com (Hons), • Wireman,

		<ul style="list-style-type: none"> • BBM (Hons), • Electrician
58	AJMER	<ul style="list-style-type: none"> • Dress Designing & Tailoring
59	JAIPUR	<ul style="list-style-type: none"> • Modern Office Management & Secretarial Practice • Dress Designing & Tailoring, • Wireman, • PGDT
60	KOTA	<ul style="list-style-type: none"> • Electrician, • Textile Designing & Printing
61	AUTHOOR	<ul style="list-style-type: none"> • -
62	CHENNAI	<ul style="list-style-type: none"> • MBA, • PGDT, • Textile Designing & Printing
63	MADURAI	<ul style="list-style-type: none"> • -
64	MTV PURAM	<ul style="list-style-type: none"> • Motor Vehicle Mechanic (4 Wheeler), • Wireman, • Textile Designing & Printing, • B.Com (Hons.), • PGDT, • Cutting & Sewing, • Office Assistant –Cum-Computer Operator
65	SRIVILLIPUTTUR	<ul style="list-style-type: none"> • Dress Designing & Tailoring
66	CHANDIGARH	<ul style="list-style-type: none"> • Dress Designing & Tailoring, • B.Com (Hons.), • MBA
67	DEHRADUN	<ul style="list-style-type: none"> • Electrician
68	ROORKEE	<ul style="list-style-type: none"> • Motor Vehicle Mechanic (4 Wheeler) • Office Assistant –Cum-Computer Operator • Electrician • Textile Designing & Printing
69	ADANBAGH, AGRA	<ul style="list-style-type: none"> • B.Com (Hons.), • MBA, • B. Ed. (Education Faculty, DEI)
70	AGRA CITY, AGRA	<ul style="list-style-type: none"> • B.Com (Hons.), • MBA
71	ALLAHABAD	<ul style="list-style-type: none"> • Dress Designing & Tailoring, • Modern Office Management & Secretarial Practice
72	BAREILLY	<ul style="list-style-type: none"> • Electrician, • Office Assistant –Cum-Computer Operator
73	DERHGAON	<ul style="list-style-type: none"> • Motor Vehicle Mechanic (4 Wheeler), • Wireman, • Dress Designing & Tailoring, • Painting & Welding (Modular Course)
74	ELLORA, AGRA	<ul style="list-style-type: none"> • B.Com (Hons.), • Electrician, • Modern Office Management & Secretarial Practice • MBA, • Textile Designing & Printing, • Cutting & Sewing

75	ETAWAH	<ul style="list-style-type: none"> • Textile Designing & Printing
76	GORAKHPUR	<ul style="list-style-type: none"> • Cutting & Sewing / Dress Designing & Tailoring
77	JHANSI	<ul style="list-style-type: none"> • Motor Vehicle Mechanic (4 Wheeler), • Electrician • Dress Designing & Tailoring
78	KANPUR (NARAMAU)	<ul style="list-style-type: none"> • Office Assistant –Cum-Computer Operator, • Motor Vehicle Mechanic (4 Wheeler), • Wireman
79	LUCKNOW	<ul style="list-style-type: none"> • Dress Designing & Tailoring, • Office Assistant –Cum-Computer Operator, • PGDT, • BBM (Hons.)
80	MEERUT	<ul style="list-style-type: none"> • Motor Vehicle Mechanic (4 Wheeler), • Office Assistant –Cum-Computer Operator
81	MIRZAPUR	<ul style="list-style-type: none"> • Modern Office Management & Secretarial Practice • Motor Vehicle Mechanic (4 Wheeler), • Electrician
82	MUZAFFAR NAGAR	<ul style="list-style-type: none"> • Office Assistant –Cum-Computer Operator, • Motor Vehicle Mechanic (4 Wheeler), • Electrician, • Dress Designing & Tailoring
83	NOIDA	<ul style="list-style-type: none"> • Modern Office Management & Secretarial Practice • Dress Designing & Tailoring, • Cutting & Sewing, • MBA, • PGDT, • Electrician
84	SAHARANPUR	<ul style="list-style-type: none"> • Office Assistant –Cum-Computer Operator
85	UNNAO	<ul style="list-style-type: none"> • Cutting & Sewing
86	VARANASI	<ul style="list-style-type: none"> • Wireman, • Textile Designing & Printing
87	KOLKATA	<ul style="list-style-type: none"> • PGDT, • Office Assistant-Cum-Computer Operator

DEI- ICT DISTANCE EDUCATION CENTRES

S. No.	ICT CENTRE	PROGRAMME
1.	Murar	<ul style="list-style-type: none"> • 3- year Diploma in Electrical Engineering
2.	Soami Nagar, New Delhi	<ul style="list-style-type: none"> • M. Phil(Electronics), • M. Phil (Computer Science), • MA(Theology), • M. Phil(Theology), • MBA(Synchronous), • Ed (Synchronous), • PGDJMC (Synchronous), • Ph D
3.	Bangalore	<ul style="list-style-type: none"> • -
4.	Rajaborari-Timarni	<ul style="list-style-type: none"> • 3- year Diploma in Electrical Engineering, • 3- year Diploma in Electronics, • Intermediate - Science/ Commerce
5.	Amritsar	<ul style="list-style-type: none"> • 3- year Diploma in Electrical Engineering
6.	Melathiruvenkatanath-puram	<ul style="list-style-type: none"> • 3- year Diploma in Electrical Engineering